

Dell Precision™ R5400

Setup and Quick Reference Guide

This guide provides an overview of features, specifications, and quick setup, software, and troubleshooting information for your computer. For more information about your operating system, devices, and other technologies, see the *Dell Technology Guide* at support.dell.com.

Model WMTE01

Notes, Notices, and Cautions



NOTE: A NOTE indicates important information that helps you make better use of your computer.



NOTICE: A NOTICE indicates either potential damage to hardware or loss of data and tells you how to avoid the problem.



CAUTION: A CAUTION indicates a potential for property damage, personal injury, or death.

If you purchased a Dell™ n Series computer, any references in this document to Microsoft® Windows® operating systems are not applicable.

Information in this document is subject to change without notice.

© 2008 Dell Inc. All rights reserved.

Reproduction in any manner whatsoever without the written permission of Dell Inc. is strictly forbidden.

Trademarks used in this text: *Dell*, *Dell Precision*, *DellConnect*, *Dell MediaDirect*, and the *DELL* logo are trademarks of Dell Inc.; *Intel* and *Xeon* are registered trademarks of Intel Corporation in the U.S. and other countries; *Bluetooth* is a registered trademark owned by Bluetooth SIG, INC., and is used by Dell under license; *Microsoft*, *Windows*, *Windows Vista*, and the *Windows Vista start button* logo are either trademarks or registered trademarks of Microsoft Corporation in the United States and/or other countries.

Other trademarks and trade names may be used in this document to refer to either the entities claiming the marks and names or their products. Dell Inc. disclaims any proprietary interest in trademarks and trade names other than its own.

This product incorporates copyright protection technology that is protected by method claims of certain U.S. patents and other intellectual property rights owned by Macrovision Corporation and other rights owners. Use of this copyright protection technology must be authorized by Macrovision Corporation, and is intended for home and other limited viewing uses only unless otherwise authorized by Macrovision Corporation. Reverse engineering or disassembly is prohibited.

Model WMTE01

June 2008

P/N KR019

Rev. A00

Contents

1	About Your Computer	7
	Front View	7
	Back View	7
	Back Panel Connectors	8
2	Setting Up Your Computer	9
	Quick Setup	9
	Connecting to the Internet	13
	Setting Up Your Internet Connection	13
	Transferring Information to a New Computer	15
	Microsoft Windows Vista	15
	Microsoft Windows XP	15
3	Specifications	19
4	Troubleshooting	29
	Troubleshooting Tools	29
	Power Light	29
	Beep Codes	30
	Error Messages	32
	System Messages	37

Troubleshooting Software and Hardware Problems	38
Dell Diagnostics.	39
Troubleshooting Tips.	44
Power Problems	45
Memory Problems	46
Lockups and Software Problems	47
Dell Technical Update Service	49
Dell Support Utility	49
5 Reinstalling Software	51
Drivers	51
Identifying Drivers	51
Reinstalling Drivers and Utilities	52
Restoring Your Operating System	55
Using Microsoft Windows System Restore.	56
Using Dell Factory Image Restore and Dell PC Restore	57
Using the Operating System Media.	60
6 Finding Information	63
7 Getting Help.	65
Obtaining Assistance	65
Technical Support and Customer Service	66
DellConnect™.	66
Online Services	66
AutoTech Service.	67
Automated Order-Status Service.	67

Problems With Your Order	67
Product Information	68
Returning Items for Warranty Repair or Credit	68
Before You Call	69
Contacting Dell	71
Index	73

About Your Computer

Front View

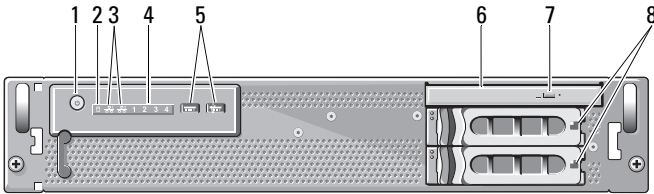

- | | | | |
|---|-----------------------------|---|-----------------------|
| 1 | power button, power light | 2 | drive activity light |
| 3 | network activity lights (2) | 4 | diagnostic lights (4) |
| 5 | USB 2.0 connectors (2) | 6 | optical drive |
| 7 | optical drive eject button | 8 | hard drive bays (2) |

Back View

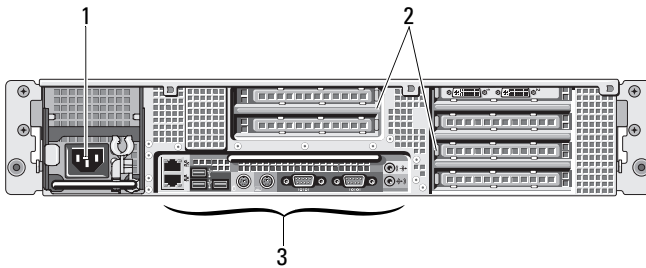

- | | | | |
|---|-----------------------|---|----------------------|
| 1 | power connector | 2 | expansion card slots |
| 3 | back panel connectors | | |

Back Panel Connectors

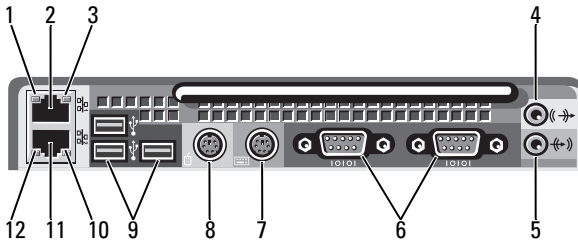

- | | | | |
|----|---------------------------------------|----|-------------------------------------|
| 1 | network link integrity light | 2 | network adapter connector (primary) |
| 3 | network activity light | 4 | line-out connector |
| 5 | line-in connector | 6 | serial connectors (2) |
| 7 | keyboard connector | 8 | mouse connector |
| 9 | USB 2.0 connectors (3) | 10 | network activity light |
| 11 | network adapter connector (secondary) | 12 | network link integrity light |

Setting Up Your Computer

Quick Setup

⚠ CAUTION: Before you begin any of the procedures in this section, read and follow the safety instructions provided with your computer.

This section describes the steps to set up your computer for the first time.

- 1 Unpack your computer and identify each item.

Keep all shipping materials in case you need them later.

✍ NOTE: Some items included with your computer may not be required for installation (see your rack installation documentation for installation instructions).

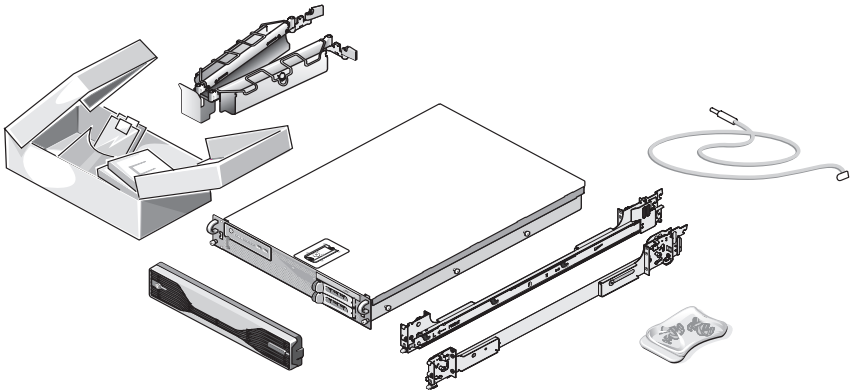

- 2** Install the rails and the computer in the rack.
See your rack installation documentation for safety instructions and instructions on installing your computer in a rack.

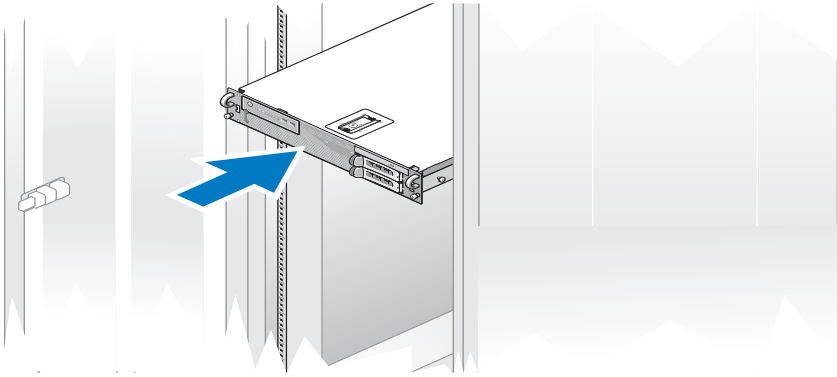

- 3** Connect the keyboard and mouse.

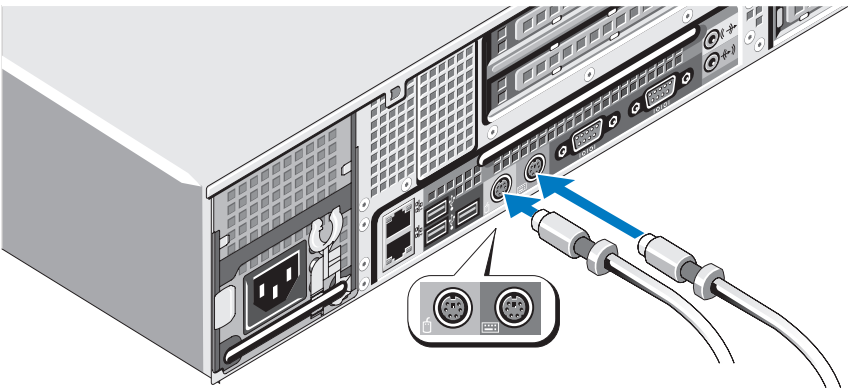

4 Connect the monitor (optional).

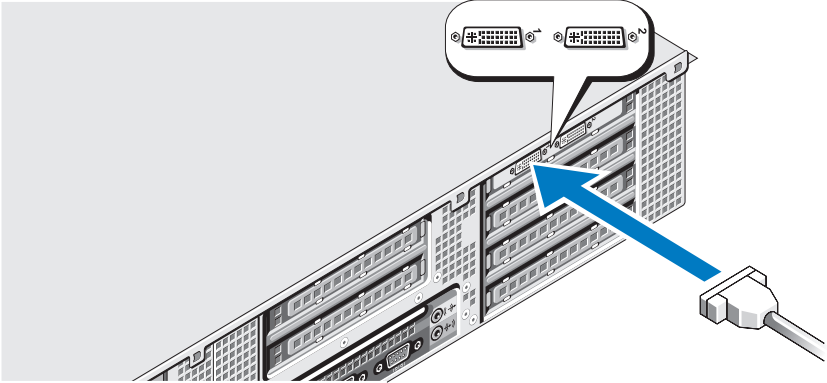

5 Connect the computer and monitor (optional) power cables.

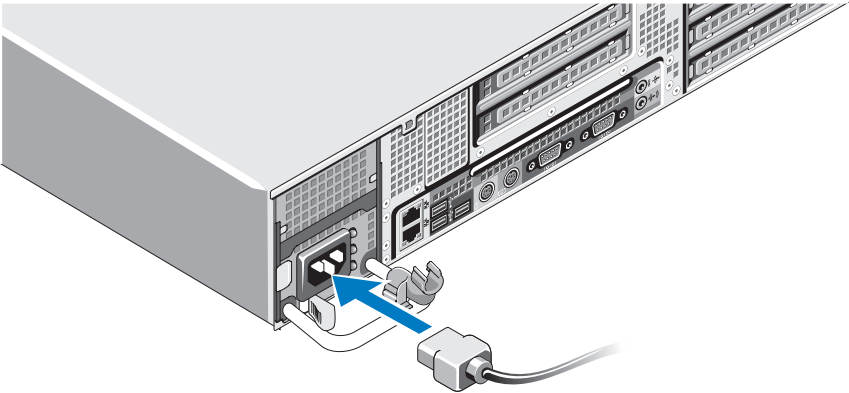

- 6 Attach the power cable retention bracket on the right bend of the power supply handle. Bend the power cable into a loop as shown in the illustration and attach the cable to the bracket's cable clasp.

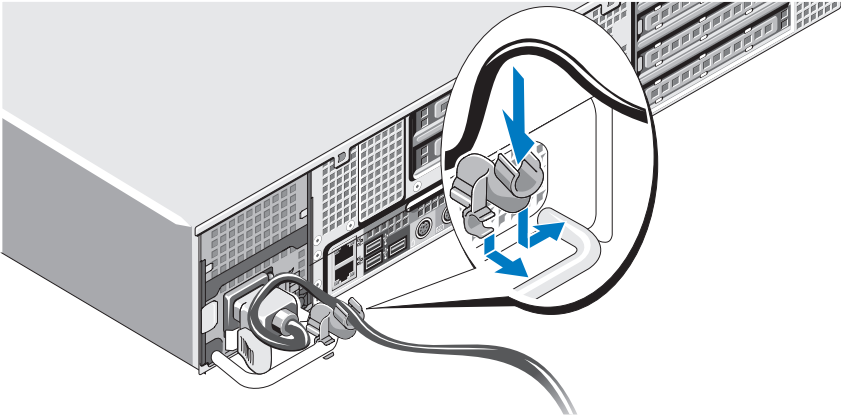

- 7 Plug the other end of the power cable into a grounded electrical outlet or a separate power source such as an uninterruptible power supply (UPS) or a power distribution unit (PDU).
- 8 Press the power button on the computer and monitor (optional).
Adjust the monitor's controls, as needed, until the displayed image is satisfactory.

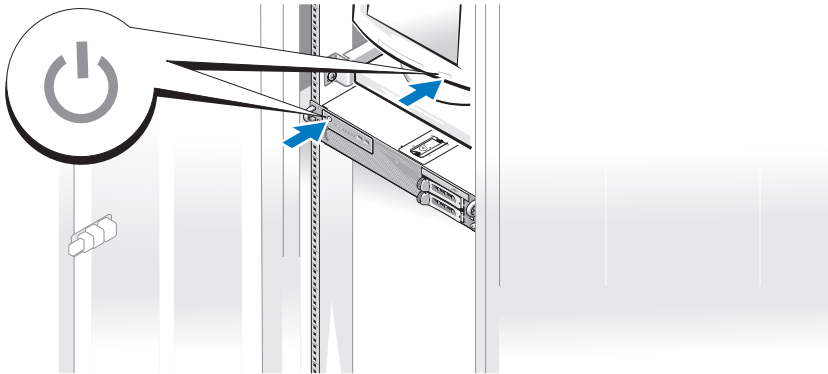

- 9 Install the bezel (optional).

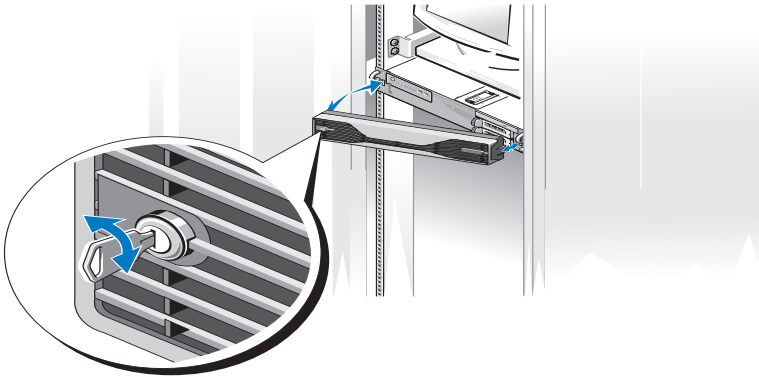

Connecting to the Internet

 **NOTE:** ISPs and ISP offerings vary by country.

To connect to the Internet, you need a network connection and an Internet service provider (ISP). Contact your ISP for setup instructions.

Setting Up Your Internet Connection

To set up an Internet connection with an ISP desktop shortcut:



- 1 Save and close any open files, and exit any open programs.
- 2 Double-click the ISP icon on the Microsoft® Windows® desktop.
- 3 Follow the instructions on the screen to complete the setup.

If you do not have an ISP icon on your desktop or if you want to set up an Internet connection with a different ISP, perform the steps in the appropriate section below.

 **NOTE:** If you are having problems connecting to the Internet, see your *Dell Technology Guide* at support.dell.com. If you cannot connect to the Internet, but have successfully connected in the past, your ISP may have a service outage. Contact your ISP to check the service status, or try connecting again later.

 **NOTE:** Have your ISP information ready. If you do not have an ISP, the Connect to the Internet wizard can help you get one.

Microsoft Windows Vista®

- 1 Save and close any open files, and exit any open programs.
 - 2 Click the Windows Vista Start button™ , and then click **Control Panel**.
 - 3 Under **Network and Internet**, click **Connect to the Internet**.
The **Connect to the Internet** window appears.
 - 4 In the **Connect to the Internet** window, click either **Broadband (PPPoE)** or **Dial-up**, depending on how you want to connect:
 - Choose **Broadband** if you are using a DSL, satellite modem, cable TV modem, or Bluetooth® wireless technology connection.
 - Choose **Dial-up** if you are using a dial-up modem or ISDN.
-  **NOTE:** If you do not know which type of connection to select, click **Help me choose** or contact your ISP.
- 5 Follow the instructions on the screen and use the setup information provided by your ISP to complete the setup.

Microsoft Windows XP

- 1 Save and close any open files, and exit any open programs.
- 2 Click **Start**→**Internet Explorer**.
The **New Connection Wizard** appears.
- 3 Click **Connect to the Internet**.
- 4 In the next window, click the appropriate option:
 - If you do not have an ISP and want to select one, click **Choose from a list of Internet service providers (ISPs)**.
 - If you have already obtained setup information from your ISP but you did not receive a setup CD, click **Set up my connection manually**.
 - If you have a CD, click **Use the CD I got from an ISP**.
- 5 Click **Next**.
If you selected **Set up my connection manually**, continue to step 6. Otherwise, follow the instructions on the screen to complete the setup.

- 6 Click the appropriate option under **How do you want to connect to the Internet?**, and then click **Next**.

 **NOTE:** If you do not know which type of connection to select, contact your ISP.

- 7 Use the setup information provided by your ISP to complete the setup.

Transferring Information to a New Computer

Microsoft Windows Vista

- 1 Click the Windows Vista Start button , and then click **Transfer files and settings**→ **Start Windows Easy Transfer**.
- 2 In the **User Account Control** dialog box, click **Continue**.
- 3 Click **Start a new transfer** or **Continue a transfer in progress**.
- 4 Follow the instructions provided on the screen by the Windows Easy Transfer wizard.

Microsoft Windows XP

The Microsoft Windows XP operating system provides the Files and Settings Transfer Wizard to transfer data, such as:

- E-mail messages
- Toolbar settings
- Window sizes
- Internet bookmarks

You can transfer data from one computer to another computer over a network or serial connection, or by storing the data on removable media, such as a writable CD or DVD.

 **NOTE:** You can transfer information from one computer to another computer by directly connecting a serial cable to the input/output (I/O) ports of the two computers.

For instructions on setting up a direct cable connection between two computers, see Microsoft Knowledge Base Article #305621, titled *How to Set Up a Direct Cable Connection Between Two Computers in Windows XP*. This information may not be available in certain countries.

Using the Files and Settings Transfer Wizard requires the *Operating System* installation media that came with your computer or a wizard disk, which the wizard can create for you.



NOTE: For more information about transferring data, search support.dell.com for document #154781 (*What Are The Different Methods To Transfer Files From My Old Computer To My New Dell™ Computer Using the Microsoft® Windows® XP Operating System?*).



NOTE: Access to the Dell Knowledge Base document may not be available in certain countries.

Files and Settings Transfer Wizard (With the Operating System Media)



NOTE: The Files and Settings Transfer Wizard designates the source computer from which data is to be transferred as the *old* computer, and designates the destination computer to which the data is going to be transferred as the *new* computer.

PREPARE THE DESTINATION COMPUTER FOR THE FILE TRANSFER

- 1 Click **Start**→ **All Programs**→ **Accessories**→ **System Tools**→ **Files and Settings Transfer Wizard**.
- 2 Under **Which computer is this?**, click **New computer**, and click **Next**.
- 3 Under **Do you have a Windows XP CD?**, click **I will use the wizard from the Windows XP CD**, and click **Next**.
- 4 Review the information under **Now go to your old computer**, and then go to the source computer. Do *not* click **Next**.

COPY DATA FROM THE SOURCE COMPUTER

- 1 Insert the Windows XP *Operating System* installation media into the source computer.
The **Welcome to Microsoft Windows XP** screen appears.
- 2 Click **Perform additional tasks**.
- 3 Under **What do you want to do?**, click **Transfer files and settings**.
The **Files and Settings Transfer Wizard** window appears.
- 4 Click **Next**.
- 5 Under **Which computer is this?**, click **Old Computer**, and click **Next**.

- 6 Under **Select a transfer method**, click the transfer method of your choice, and click **Next**.
- 7 Under **What do you want to transfer?**, click to select the data you want to transfer, and click **Next**.

The selected data is copied and the **Completing the Collection Phase** screen appears.

- 8 Click **Finish**.

TRANSFER DATA TO THE DESTINATION COMPUTER

- 1 Go to the destination computer.
- 2 Under **Now go to your old computer**, click **Next**.
- 3 Under **Where are the files and settings?**, click to select the method you chose for transferring your settings and files, and then click **Next**.

The wizard reads the collected files and settings and applies them to the destination computer. When the transfer is complete, the **Finished** screen appears.

- 4 Click **Finished**, and then restart the computer.

Files and Settings Transfer Wizard (Without the Operating System Media)

To run the Files and Settings Transfer Wizard without the *Operating System* installation media, you must create a wizard disk. The wizard disk allows you to create a backup image file on removable media.



NOTE: The Files and Settings Transfer Wizard designates the source computer from which data is to be transferred as the *old* computer, and designates the destination computer to which the data is going to be transferred as the *new* computer.

CREATE A WIZARD DISK

- 1 On the destination computer, click **Start**→ **All Programs**→ **Accessories**→ **System Tools**→ **Files and Settings Transfer Wizard**.
- 2 Under **Which computer is this?**, click **New computer**, and click **Next**.
- 3 Under **Do you have a Windows XP CD?**, click **I want to create a Wizard Disk in the following drive**, and click **Next**.
- 4 Insert removable media, such as a writable CD or DVD, and click **OK**.

- 5 Review the information under **Now go to your old computer**, and then go to the source computer. *Do not* click **Next**.

COPY DATA FROM THE SOURCE COMPUTER

- 1 Insert the wizard disk into the source computer.
- 2 Click **Start**→ **Run**.
- 3 Click **Browse...** and navigate to **fastwiz** on the wizard disk, and click **OK**.
- 4 Under **Which computer is this?**, click **Old Computer**, and click **Next**.
- 5 Under **Select a transfer method**, click the transfer method of your choice, and click **Next**.
- 6 Under **What do you want to transfer?**, click to select the data you want to transfer, and click **Next**.

The selected data is copied and the **Completing the Collection Phase** screen appears.

- 7 Click **Finish**.

TRANSFER DATA TO THE DESTINATION COMPUTER

- 1 Go to the destination computer.
- 2 Under **Now go to your old computer**, click **Next**.
- 3 Under **Where are the files and settings?**, click to select the method you chose for transferring your settings and files, and click **Next**.

The wizard reads the collected files and settings and applies them to the destination computer. When the transfer is complete, the **Finished** screen appears.

- 4 Click **Finished**, and then restart the computer.

Specifications



NOTE: Offerings may vary by region. For more information regarding the configuration of your computer, click **Start**→ **Help and Support** and select the option to view information about your computer.

Processor

Processor type	one or two Dual-Core Intel® Xeon® 5200 processors one or two Quad-Core Intel Xeon 5400 processors
Level 2 (L2) cache	Dual-Core Intel Xeon 5200 processor: 6 MB Quad-Core Intel Xeon 5400 processor: 12 MB
Front side bus (FSB)	1333 MHz

System Information

Chipset	Intel 5400
Data bus width	64 bits
Address bus width	38 bits
DMA channels	seven
Interrupt levels	24
BIOS chip (NVRAM)	8 Mb

System Information (continued)

NIC	<p>integrated network interface with ASF 2.0 support as defined by DMTF, capable of 10/100/1000-Mbps communication:</p> <ul style="list-style-type: none">• green — A good connection exists between a 10-Mbps network and the computer.• orange — A good connection exists between a 100-Mbps network and the computer.• yellow — A good connection exists between a 1000-Mbps (1-Gb) network and the computer.• off — The computer is not detecting a physical connection to the network. <p>NOTE: ASF 2.0 support and wakeup on LAN are not available on the secondary NIC and are not available on the primary NIC in <i>teaming</i> mode.</p>
RAID support	RAID 0 and RAID 1 (mirroring)

Memory

Type	667-MHz DDR2 ECC fully buffered DIMMs (FBD)
Memory connectors	four
Memory capacities	256 MB, 512 MB, 1 GB, 2 GB, 4 GB, and 8 GB
Minimum memory	256 MB
Maximum memory	32 GB

Drives

Externally accessible	<p>up to two 3.5-inch drive bays (FlexBay) one 5.25-inch slimline drive bay</p> <p> NOTICE: Hard drives are <i>not</i> hot swappable.</p>
Available devices	<p>up to two 3.5-inch SATA hard drives one slimline SATA optical drive</p>

Video

Type	PCI Express x16 (two slots)
------	-----------------------------

Audio

Type integrated ADI 1984 High Definition Audio CODEC and AC97/High Definition digital controller

Expansion Bus

Bus type PCI 2.3
PCI Express 1.0a
SATA 2.0
USB 2.0

Bus speed/transfer rate PCI: 133 MB/s
PCI Express:
x8 slot bidirectional speed — 500 MB/s
x16 slot bidirectional speed — 1 GB/s
SATA 1.0 and 2.0: 150 and 300 Mbps per drive
USB 2.0: up to 480 Mbps (high speed)

Expansion slots:

Center riser:

PCI-X one full height, full length 3.3 V, 64 bit, 100 MHz
PCI one PCI Universal, full height, full length 5.0 V, 32 bit, 33 MHz

NOTE: The center riser expansion slot configuration varies according to the riser installed on your computer.

Center riser:

PCI-X one full height, full length 3.3 V, 64 bit, 100 MHz
PCI Express x8 one full height, full length x8 lane

NOTE: The center riser expansion slot configuration varies according to the riser installed on your computer.

Outer riser:

PCI Express x16 (two slots) two full height, full length x16 lane

Expansion Bus (continued)

PCI:

Connector	one
Connector size	124 pins
Connector data width (maximum)	32 bits

PCI-X:

Connector	one
Connector size	188 pins
Connector data width (maximum)	64 bits

PCI Express x8:

Connector	one x16 (supports x8, x4 and x1 cards)
Connector size	164 pins
Connector data width (maximum)	x8 PCI Express lane

PCI Express x16:

Connector	two x16
Connector size	164 pins
Connector data width (maximum)	x16 PCI Express lane

Connectors

External connectors:

USB	two front panel USB 2.0-compliant connectors three back panel USB 2.0-compliant connectors
Network adapter (NIC)	two back panel RJ-45 connectors (for integrated 1-GB NICs)
Video	back panel DVI connector (on graphics card) back panel VGA connector (on graphics card)

Connectors *(continued)*

PS/2 (keyboard and mouse)	two back panel 6-pin mini-DIN
Serial	two back panel 9-pin connectors (16550C-compatible)
Audio	two back panel connectors (line-in and line-out)
System board connectors:	
Serial ATA	three 7-pin connectors
Internal USB	one 10-pin connector
Fans	two 4-pin connectors two 5-pin connectors
PCI (on center riser)	one 124-pin connector
PCI-X (on center riser)	one 188-pin connector
PCI Express x8 (on center riser)	one 164-pin connector
PCI Express x16 (on outer riser)	two 164-pin connectors
Front control panel	one 20-pin connector
Front panel USB	one 10-pin connector
Processor	two 775-pin connectors
Memory	four 240-pin connectors
Power 12 V	three 6-pin connectors
Power (main)	one 24-pin connector

Controls and Lights

Front panel:

Power button	push button — Press the power button to turn on the computer.  NOTICE: To avoid losing data, do not turn off the computer by pressing the power button. Instead, perform an operating system shutdown.
Power light	green light — Blinking green in sleep state; solid green in normal power-on state. amber light — Blinking amber indicates that an internal power problem may exist; solid amber indicates that a device may be malfunctioning or incorrectly installed (see "Power Problems" on page 45).
Network activity lights (2)	green blinking light — Flashes when the computer is transmitting or receiving network data. A high volume of network traffic may make this light appear to be in a steady <i>on</i> state.
Hard drive activity light	green light — The hard drive activity light is on when the computer reads data from or writes data to the hard drive. The light may also be on when a device such as an optical drive is in operation.

Controls and Lights *(continued)*

Back panel:

Link integrity light (on integrated network adapter) The network link light is on when a good connection exists between a 10-Mbps, 100-Mbps, or 1000-Mbps (1-Gbps) network and the computer.

- green — A good connection exists between a 10-Mbps network and the computer.
- orange — A good connection exists between a 100-Mbps network and the computer.
- yellow — A good connection exists between a 1000-Mbps (1-Gb) network and the computer.
- off — The computer is not detecting a physical connection to the network.

NOTE: ASF 2.0 support and wakeup on LAN are not available on the secondary NIC and are not available on the primary NIC in *teaming* mode.

Network activity light (on integrated network adapter) yellow blinking light — Flashes when the computer is transmitting or receiving network data. A high volume of network traffic may make this light appear to be in a steady *on* state.

Power

DC power supply:

Wattage 750 W

Maximum heat dissipation For 750-W power supply: 2559 BTU/hr

NOTE: Heat dissipation is calculated based upon the power supply wattage rating.

Voltage Autoranging power supply: 90–240 VAC at 50–60 Hz

NOTE: See the safety information that shipped with your computer for important voltage setting information.

Coin cell battery 3-V CR2032 lithium coin cell

Physical

Height	8.656 cm (3.40 inches)
Width	42.62 cm (16.78 inches)
Depth:	
With front bezel	68.45 cm (26.95 inches)
Without front bezel	73.25 cm (28.84 inches)
Weight:	
With front bezel	20.85 kg (45.97 lb)
Without front bezel	20.45 kg (45.08 lb)

Environmental

Temperature:

Operating 10° to 35°C (50° to 95°F) with a maximum temperature gradation of 10°C per hour

NOTE: For altitudes above 2950 ft, the maximum operating temperature is derated 1°F/550 ft.

Storage -40° to 65°C (-40° to 149°F) with a maximum temperature gradation of 20°C per hour

Relative humidity: 20% to 80% (noncondensing)

Operating 20% to 80% (noncondensing) with a maximum humidity gradation of 10% per hour

Storage 5% to 95% (noncondensing) with a maximum humidity gradation of 10% per hour

Maximum wet bulb (MWB) 38°C under any conditions

Maximum vibration:

Operational random vibration 0.26 G at 5–350 Hz for 2 minutes per side (operational sides only)

Storage 0.5 G at 3–200 Hz for 15 minutes

Environmental (continued)

Maximum shock:

Operating	40 G +/- 5% with pulse duration of 2 msec +/-10% (equivalent to 51 cm/sec [20 inches/sec])
Storage	105 G +/- 5% with pulse duration of 2 msec +/- 10% (equivalent to 127 cm/sec [50 inches/sec])

Altitude:

Operating	-16 to 3048 m (-50 to 10,000 ft)
Storage	-16 to 10,600 m (-50 to 35,000 ft)
Airborne contaminant level	G2 or lower as defined by ISA-S71.04-1985

Troubleshooting



CAUTION: To guard against the likelihood of electric shock, laceration by moving fan blades, or other expected injuries, always unplug your computer from the electrical outlet before opening the cover.



CAUTION: Before you begin any of the procedures in this section, follow the safety instructions that shipped with your computer.

Troubleshooting Tools

Power Light



CAUTION: Before you begin any of the procedures in this section, read and follow the safety instructions provided with your computer.

The power light located on the front of the computer illuminates and remains solid or blinks to indicate different states:

- If the power light is green and the computer is not responding, see "Diagnostic Lights" in your *Service Manual*.
- If the power light is blinking green, the computer is in standby mode. Press a key on the keyboard, move the mouse, or press the power button to resume normal operation.
- If the power light is off, the computer is either turned off or is not receiving power.
 - Reseat the power cable into both the power connector on the back of the computer and the electrical outlet.
 - If the computer is plugged into a power strip, ensure that the power strip is plugged into an electrical outlet and that the power strip is turned on.
 - Bypass power protection devices, power strips, and power extension cables to verify that the computer turns on properly.
 - Ensure that the electrical outlet is working by testing it with another device, such as a lamp.

- Ensure that the main power cable and front panel cable are securely connected to the system board (see your *Service Manual* on the Dell Support website at support.dell.com).
- If the power light is blinking amber, the computer is receiving electrical power, but an internal power problem may exist.
 - Ensure that the processor power cable is securely connected to the system board (see your *Service Manual* on the Dell Support website at support.dell.com).
- If the power light is steady amber, a device may be malfunctioning or incorrectly installed.
 - Remove and then reinstall the memory modules (see your *Service Manual* on the Dell Support website at support.dell.com).
 - Remove and then reinstall any cards (see your *Service Manual* on the Dell Support website at support.dell.com).
- Eliminate interference. Some possible causes of interference are:
 - Power, keyboard, and mouse extension cables
 - Too many devices on a power strip
 - Multiple power strips connected to the same electrical outlet

Beep Codes

Your computer may emit a series of beeps during start-up. The series of beeps, called a beep code, can help you identify a problem with your computer.

If your computer emits a series of beeps during start-up:

- 1 Write down the beep code on the "Diagnostics Checklist" on page 70.
- 2 Run the Dell Diagnostics to identify a more serious cause (see "Troubleshooting Tips" on page 44).
- 3 Contact Dell for technical assistance (see "Contacting Dell" on page 71).

Code	Cause
1-1-2	Microprocessor register failure
1-1-3	NVRAM read/write failure
1-1-4	ROM BIOS checksum failure

Code	Cause
1-2-1	Programmable interval timer failure
1-2-2	DMA initialization failure
1-2-3	DMA page register read/write failure
1-3	Video Memory Test failure
1-3-1 through 2-4-4	Memory not being properly identified or used
1-3-2	Memory problem
3-1-1	Slave DMA register failure
3-1-2	Master DMA register failure
3-1-3	Master interrupt mask register failure
3-1-4	Slave interrupt mask register failure
3-2-2	Interrupt vector loading failure
3-2-4	Keyboard Controller Test failure
3-3-1	NVRAM power loss
3-3-2	Invalid NVRAM configuration
3-3-4	Video Memory Test failure
3-4-1	Screen initialization failure
3-4-2	Screen retrace failure
3-4-3	Search for video ROM failure
4-2-1	No timer tick
4-2-2	Shutdown failure
4-2-3	Gate A20 failure
4-2-4	Unexpected interrupt in protected mode
4-3-1	Memory failure above address 0FFFFh
4-3-3	Timer-chip counter 2 failure
4-3-4	Time-of-day clock stopped
4-4-1	Serial or parallel port test failure
4-4-2	Failure to decompress code to shadowed memory

Code	Cause
4-4-3	Math-coprocessor test failure
4-4-4	Cache test failure

Error Messages



CAUTION: Before you begin any of the procedures in this section, follow the safety instructions that shipped with your computer.



NOTE: If the message you received is not listed below, see the documentation for either the operating system or the program that was running when the message appeared.

AUXILIARY DEVICE FAILURE — The touch pad or external mouse may be faulty. For an external mouse, check the cable connection. Enable the **Pointing Device** option in the system setup program. See your *Service Manual* at support.dell.com for more information. If the problem persists, contact Dell (see "Contacting Dell" on page 71).

BAD COMMAND OR FILE NAME — Ensure that you have spelled the command correctly, put spaces in the proper place, and used the correct pathname.

CACHE DISABLED DUE TO FAILURE — The primary cache internal to the microprocessor has failed. Contact Dell (see "Contacting Dell" on page 71).

CD DRIVE CONTROLLER FAILURE — The CD drive does not respond to commands from the computer.

DATA ERROR — The hard drive cannot read the data.

DECREASING AVAILABLE MEMORY — One or more memory modules may be faulty or improperly seated. Reinstall the memory modules and, if necessary, replace them. See your *Service Manual* at support.dell.com for more information.

DISK C: FAILED INITIALIZATION — The hard drive failed initialization. Run the hard drive tests in the Dell Diagnostics (see "Dell Diagnostics" on page 39).

DRIVE NOT READY — The operation requires a hard drive in the bay before it can continue. Install a hard drive in the hard drive bay. See your *Service Manual* at support.dell.com for more information.

ERROR READING PCMCIA CARD — The computer cannot identify the ExpressCard. Reinsert the card or try another card. See your *Service Manual* at support.dell.com for more information.

EXTENDED MEMORY SIZE HAS CHANGED — The amount of memory recorded in nonvolatile memory (NVRAM) does not match the memory installed in the computer. Restart the computer. If the error appears again, contact Dell (see "Contacting Dell" on page 71).

THE FILE BEING COPIED IS TOO LARGE FOR THE DESTINATION DRIVE — The file that you are trying to copy is too large to fit on the disk, or the disk is full. Try copying the file to a different disk or use a larger capacity disk.

A FILENAME CANNOT CONTAIN ANY OF THE FOLLOWING CHARACTERS: \ / : * ? " < > | — Do not use these characters in filenames.

GATE A20 FAILURE — A memory module may be loose. Reinstall the memory modules and, if necessary, replace them. See your *Service Manual* at support.dell.com for more information.

GENERAL FAILURE — The operating system is unable to carry out the command. The message is usually followed by specific information—for example, `Printer out of paper`. Take the appropriate action.

HARD-DISK DRIVE CONFIGURATION ERROR — The computer cannot identify the drive type. Shut down the computer, remove the hard drive (see your *Service Manual* at support.dell.com), and boot the computer from a CD. Then, shut down the computer, reinstall the hard drive, and restart the computer. Run the Hard Disk Drive tests in the Dell Diagnostics (see "Dell Diagnostics" on page 39).

HARD-DISK DRIVE CONTROLLER FAILURE 0 — The hard drive does not respond to commands from the computer. Shut down the computer, remove the hard drive (see your *Service Manual* at support.dell.com), and boot the computer from a CD. Then, shut down the computer, reinstall the hard drive, and restart the computer. If the problem persists, try another drive. Run the Hard Disk Drive tests in the Dell Diagnostics (see "Dell Diagnostics" on page 39).

HARD-DISK DRIVE FAILURE — The hard drive does not respond to commands from the computer. Shut down the computer, remove the hard drive (see your *Service Manual* at support.dell.com), and boot the computer from a CD. Then, shut down the computer, reinstall the hard drive, and restart the computer. If the problem persists, try another drive. Run the Hard Disk Drive tests in the Dell Diagnostics (see "Dell Diagnostics" on page 39).

HARD-DISK DRIVE READ FAILURE — The hard drive may be defective. Shut down the computer, remove the hard drive (see your *Service Manual* at support.dell.com), and boot the computer from a CD. Then, shut down the

computer, reinstall the hard drive, and restart the computer. If the problem persists, try another drive. Run the Hard Disk Drive tests in the Dell Diagnostics (see "Dell Diagnostics" on page 39).

INSERT BOOTABLE MEDIA — The operating system is trying to boot to nonbootable media, such as a floppy disk or CD. Insert bootable media.

INVALID CONFIGURATION INFORMATION-PLEASE RUN SYSTEM SETUP PROGRAM — The system configuration information does not match the hardware configuration. The message is most likely to occur after a memory module is installed. Correct the appropriate options in the system setup program. See your *Service Manual* at support.dell.com for more information.

KEYBOARD CLOCK LINE FAILURE — For external keyboards, check the cable connection. Run the Keyboard Controller test in the Dell Diagnostics (see "Dell Diagnostics" on page 39).

KEYBOARD CONTROLLER FAILURE — For external keyboards, check the cable connection. Restart the computer, and avoid touching the keyboard or the mouse during the boot routine. Run the Keyboard Controller test in the Dell Diagnostics (see "Dell Diagnostics" on page 39).

KEYBOARD DATA LINE FAILURE — For external keyboards, check the cable connection. Run the Keyboard Controller test in the Dell Diagnostics (see "Dell Diagnostics" on page 39).

KEYBOARD STUCK KEY FAILURE — For external keyboards or keypads, check the cable connection. Restart the computer, and avoid touching the keyboard or keys during the boot routine. Run the Stuck Key test in the Dell Diagnostics (see "Dell Diagnostics" on page 39).

LICENSED CONTENT IS NOT ACCESSIBLE IN MEDIADIRECT — Dell MediaDirect™ cannot verify the Digital Rights Management (DRM) restrictions on the file, so the file cannot be played (see "Dell Diagnostics" on page 39).

MEMORY ADDRESS LINE FAILURE AT ADDRESS, READ VALUE EXPECTING VALUE — A memory module may be faulty or improperly seated. Reinstall the memory modules and, if necessary, replace them. See your *Service Manual* at support.dell.com for more information.

MEMORY ALLOCATION ERROR — The software you are attempting to run is conflicting with the operating system, another program, or a utility. Shut down the computer, wait 30 seconds, and then restart it. Try to run the program again. If the error message still appears, see the software documentation.

MEMORY DATA LINE FAILURE AT ADDRESS, READ VALUE EXPECTING VALUE — A memory module may be faulty or improperly seated. Reinstall the memory modules and, if necessary, replace them. See your *Service Manual* at support.dell.com for more information.

MEMORY DOUBLE WORD LOGIC FAILURE AT ADDRESS, READ VALUE EXPECTING VALUE — A memory module may be faulty or improperly seated. Reinstall the memory modules and, if necessary, replace them. See your *Service Manual* at support.dell.com for more information.

MEMORY ODD/EVEN LOGIC FAILURE AT ADDRESS, READ VALUE EXPECTING VALUE — A memory module may be faulty or improperly seated. Reinstall the memory modules and, if necessary, replace them. See your *Service Manual* at support.dell.com for more information.

MEMORY WRITE/READ FAILURE AT ADDRESS, READ VALUE EXPECTING VALUE — A memory module may be faulty or improperly seated. Reinstall the memory modules and, if necessary, replace them. See your *Service Manual* at support.dell.com for more information.

NO BOOT DEVICE AVAILABLE — The computer cannot find the hard drive. If the hard drive is your boot device, ensure that the drive is installed, properly seated, and partitioned as a boot device.

NO BOOT SECTOR ON HARD DRIVE — The operating system may be corrupted. Contact Dell (see "Contacting Dell" on page 71).

NO TIMER TICK INTERRUPT — A chip on the system board may be malfunctioning. Run the System Set tests in the Dell Diagnostics (see "Dell Diagnostics" on page 39).

NOT ENOUGH MEMORY OR RESOURCES. EXIT SOME PROGRAMS AND TRY AGAIN — You have too many programs open. Close all windows and open the program that you want to use.

OPERATING SYSTEM NOT FOUND — Reinstall the hard drive (see your *Service Manual* at support.dell.com). If the problem persists, contact Dell (see "Contacting Dell" on page 71).

OPTIONAL ROM BAD CHECKSUM — The optional ROM has failed. Contact Dell (see "Contacting Dell" on page 71).

A REQUIRED .DLL FILE WAS NOT FOUND — The program that you are trying to open is missing an essential file. Remove and then reinstall the program.

Microsoft® Windows Vista®:

- 1 Click the Windows Vista start button  → **Control Panel** → **Programs** → **Programs and Features**.
- 2 Select the program you want to remove.
- 3 Click **Uninstall**.
- 4 See the program documentation for installation instructions.

Microsoft Windows® XP:

- 1 Click **Start** → **Control Panel** → **Add or Remove Programs** → **Programs and Features**.
- 2 Select the program you want to remove.
- 3 Click **Uninstall**.
- 4 See the program documentation for installation instructions.

SECTOR NOT FOUND — The operating system cannot locate a sector on the hard drive. You may have a defective sector or corrupted FAT on the hard drive. Run the Windows error-checking utility to check the file structure on the hard drive. See Windows Help and Support for instructions (click **Start** → **Help and Support**). If a large number of sectors are defective, back up the data (if possible), and then reformat the hard drive.

SEEK ERROR — The operating system cannot find a specific track on the hard drive.

SHUTDOWN FAILURE — A chip on the system board may be malfunctioning. Run the System Set tests in the Dell Diagnostics (see "Dell Diagnostics" on page 39).

TIME-OF-DAY CLOCK LOST POWER — System configuration settings are corrupted. Connect your computer to an electrical outlet to charge the battery. If the problem persists, try to restore the data by entering the system setup program, and then immediately exit the program (see your *Service Manual* at support.dell.com). If the message reappears, contact Dell (see "Contacting Dell" on page 71).

TIME-OF-DAY CLOCK STOPPED — The reserve battery that supports the system configuration settings may require recharging. Connect your computer to an electrical outlet to charge the battery. If the problem persists, contact Dell (see "Contacting Dell" on page 71).

TIME-OF-DAY NOT SET-PLEASE RUN THE SYSTEM SETUP PROGRAM — The time or date stored in the system setup program does not match the system clock. Correct the settings for the **Date** and **Time** options. See your *Service Manual* at support.dell.com for more information.

TIMER CHIP COUNTER 2 FAILED — A chip on the system board may be malfunctioning. Run the System Set tests in the Dell Diagnostics (see "Dell Diagnostics" on page 39).

UNEXPECTED INTERRUPT IN PROTECTED MODE — The keyboard controller may be malfunctioning, or a memory module may be loose. Run the System Memory tests and the Keyboard Controller test in the Dell Diagnostics (see "Dell Diagnostics" on page 39).

X:\ IS NOT ACCESSIBLE. THE DEVICE IS NOT READY — Insert a disk into the drive and try again.

System Messages



NOTE: If the message you received is not listed below, see the documentation for either the operating system or the program that was running when the message appeared.

ALERT! PREVIOUS ATTEMPTS AT BOOTING THIS SYSTEM HAVE FAILED AT CHECKPOINT [NNNN]. FOR HELP IN RESOLVING THIS PROBLEM, PLEASE NOTE THIS CHECKPOINT AND CONTACT DELL TECHNICAL SUPPORT — The computer failed to complete the boot routine three consecutive times for the same error (see "Contacting Dell" on page 71 for assistance).

CMOS CHECKSUM ERROR — Possible system board failure or RTC battery low. Replace the battery (see your *Service Manual* on the Dell Support website at support.dell.com or see "Contacting Dell" on page 71 for assistance).

FAN [X] FAILURE — Fan failure. Replace the defective fan (see your *Service Manual* on the Dell Support website at support.dell.com).

HARD-DISK READ FAILURE — Possible hard drive failure during hard drive boot test (see "Contacting Dell" on page 71 for assistance).

KEYBOARD FAILURE — Keyboard failure or keyboard cable loose (see your *Service Manual* on the Dell Support website at support.dell.com).

NO BOOT DEVICE AVAILABLE — The system cannot detect a bootable device or partition.

- If the optical drive is your boot device, ensure that the cables are connected and that a bootable disc is in the drive.

- If the hard drive is your boot device, ensure that the cables are connected and that the drive is installed properly and partitioned as a boot device.
- Enter the system setup program and ensure that the boot sequence information is correct (see your *Service Manual* on the Dell Support website at support.dell.com).

NO TIMER TICK INTERRUPT — A chip on the system board might be malfunctioning or system board failure (see "Contacting Dell" on page 71 for assistance).

NOTICE – HARD DRIVE SELF MONITORING SYSTEM HAS REPORTED THAT A PARAMETER HAS EXCEEDED ITS NORMAL OPERATING RANGE. DELL RECOMMENDS THAT YOU BACK UP YOUR DATA REGULARLY. A PARAMETER OUT OF RANGE MAY OR MAY NOT INDICATE A POTENTIAL HARD DRIVE PROBLEM. — S.M.A.R.T error, possible hard drive failure. This feature can be enabled or disabled in BIOS setup.

Troubleshooting Software and Hardware Problems

If a device is either not detected during the operating system setup or is detected, but incorrectly configured, you can use the Hardware Troubleshooter to resolve the incompatibility.

Windows Vista:

- 1 Click the Windows Vista start button , and click **Help and Support**.
- 2 Type `hardware troubleshooter` in the search field and press <Enter> to start the search.
- 3 In the search results, select the option that best describes the problem and follow the remaining troubleshooting steps.

Windows XP:

- 1 Click **Start**→ **Help and Support**.
- 2 Type `hardware troubleshooter` in the search field and press <Enter> to start the search.
- 3 In the **Fix a Problem** section, click **Hardware Troubleshooter**.
- 4 In the **Hardware Troubleshooter** list, select the option that best describes the problem and click **Next** to follow the remaining troubleshooting steps.

Dell Diagnostics



CAUTION: Before you begin any of the procedures in this section, read and follow the safety instructions provided with your computer.

When to Use the Dell Diagnostics

If you experience a problem with your computer, perform the checks in "Troubleshooting Tips" on page 44, and then run the Dell Diagnostics before contacting Dell for assistance.

Start the Dell Diagnostics from your hard drive or from the *Drivers and Utilities* media provided with your computer.



NOTE: The *Drivers and Utilities* media is optional and may not ship with your computer.



NOTE: The Dell Diagnostics only operate on Dell computers.

Starting the Dell Diagnostics From Your Hard Drive

Before running the Dell Diagnostics, enter the system setup program (see your *Service Manual* on the Dell Support website at support.dell.com) to review your computer's configuration information, and ensure that the device you want to test is displayed in the system setup program and is active.

The Dell Diagnostics is located on a separate diagnostic utility partition on your hard drive.



NOTE: If your computer does not display a screen image, contact Dell (see "Contacting Dell" on page 71).

- 1 Ensure that the computer is connected to an electrical outlet that is known to be working properly.
- 2 Turn on (or restart) your computer.
- 3 When the DELL logo appears, press <F12> immediately.



NOTE: Keyboard failure may result when a key is held down for extended periods of time. To avoid possible keyboard failure, press and release <F12> in even intervals to open the Boot Device Menu.

If you wait too long and the operating system logo appears, continue to wait until you see the Microsoft Windows desktop, and then shut down your computer and try again.

- 4 Use the up- and down-arrow keys to select **Diagnostics** from the boot menu and then press <Enter>.

The computer runs the Pre-boot System Assessment (PSA), a series of initial tests of your system board, keyboard, display, memory, hard drive, and so on.

- Answer any questions that appear.
- If failures are detected, write down the error code(s) and see "Contacting Dell" on page 370.
- If the Pre-boot System Assessment completes successfully, the following message appears: "Booting Dell Diagnostic Utility Partition. Press any key to continue."



NOTE: If you see a message stating that no diagnostics utility partition has been found, run the Dell Diagnostics from your *Drivers and Utilities* media (see "Starting the Dell Diagnostics From the Drivers and Utilities Media" on page 41).

- 5 Press any key to start the Dell Diagnostics from the diagnostics utility partition on your hard drive.
- 6 Press <Tab> to select **Test System** and then press <Enter>.



NOTE: It is recommended that you select **Test System** to run a complete test on your computer. Selecting **Test Memory** initiates the extended memory test, which can take up to thirty minutes or more to complete. When the test completes, record the test results and then press any key to return to the previous menu.

- 7 At the Dell Diagnostics Main Menu, left-click with the mouse, or press <Tab> and then <Enter>, to select the test you want to run (see "Dell Diagnostics Main Menu" on page 42).



NOTE: Write down any error codes and problem descriptions exactly as they appear and follow the instructions on the screen.

- 8 After all tests have completed, close the test window to return to the Dell Diagnostics Main Menu.
- 9 Close the Main Menu window to exit the Dell Diagnostics and restart the computer.

Starting the Dell Diagnostics From the Drivers and Utilities Media

Before running the Dell Diagnostics, enter the system setup program (see your *Service Manual* on the Dell Support website at support.dell.com) to review your computer's configuration information, and ensure that the device you want to test is displayed in the system setup program and is active.

- 1 Insert the *Drivers and Utilities* media into the optical drive.
- 2 Restart your computer.
- 3 When the DELL logo appears, press <F12> immediately.



NOTE: Keyboard failure may result when a key is held down for extended periods of time. To avoid possible keyboard failure, press and release <F12> in even intervals to open the Boot Device Menu.

If you wait too long and the operating system logo appears, continue to wait until you see the Microsoft Windows desktop, and then shut down your computer and try again.

- 4 When the boot device list appears, use the up- or down- arrow keys to highlight CD/DVD/CD-RW Drive then press <Enter>.



NOTE: Using the one-time boot menu changes the boot sequence for the current boot only. Upon restart, the computer boots according to the boot sequence specified in the system setup program.

- 5 Press any key to confirm that you want to start from the CD/DVD.

If you wait too long and the operating system logo appears, continue to wait until you see the Microsoft Windows desktop, and then shut down your computer and try again.

- 6 Type 1 to Run the 32 Bit Dell Diagnostics.

- 7 At the Dell Diagnostics Menu, type 1 to select Dell 32-bit Diagnostics for Resource CD (graphical user interface).

- 8 Press <Tab> to select Test System and then press <Enter>.



NOTE: It is recommended that you select **Test System** to run a complete test on your computer. Selecting **Test Memory** initiates the extended memory test, which can take up to thirty minutes or more to complete. When the test completes, record the test results and then press any key to return to the previous menu.

- At the Dell Diagnostics Main Menu, left-click with the mouse, or press <Tab> and then <Enter>, to select the test you want to run (see "Dell Diagnostics Main Menu" on page 42).

 **NOTE:** Write down any error codes and problem descriptions exactly as they appear and follow the instructions on the screen.

- After all tests have completed, close the test window to return to the Dell Diagnostics Main Menu.
- Close the Main Menu window to exit the Dell Diagnostics and restart the computer.
- Remove the *Drivers and Utilities* media from the optical drive.

Dell Diagnostics Main Menu

After the Dell Diagnostics loads the following menu appears:

Option	Function
Test Memory	Run the stand-alone memory test
Test System	Run system diagnostics
Exit	Exit the diagnostics

Press <Tab> to select the test you want to run and then press <Enter>.

 **NOTE:** It is recommended that you select **Test System** to run a complete test on your computer. Selecting **Test Memory** initiates the extended memory test, which can take up to thirty minutes or more to complete. When the test completes, record the test results and then press any key to return to this menu.

After **Test System** is selected, the following menu appears:

Option	Function
Express Test	Performs a quick test of devices in the system. This typically can take 10 to 20 minutes. NOTE: The Express Test requires no interaction on your part. Run Express Test first to increase the possibility of tracing a problem quickly.

Option	Function <i>(continued)</i>
Extended Test	Performs a thorough check of devices in the system. This typically can take an hour or more. NOTE: The Extended Test periodically requires your input to answer specific questions.
Custom Test	Use to test a specific device or customize the tests to be run.
Symptom Tree	This option allows you to select tests based on a symptom of the problem you are having. This option lists the most common symptoms.

 **NOTE:** It is recommended that you select **Extended Test** to perform a more thorough check of devices in the computer.

For any problem encountered during a test, a message appears with an error code and a description of the problem. Write down the error code and problem description exactly as it appears and follow the instructions on the screen. If you cannot resolve the problem, contact Dell (see "Contacting Dell" on page 112).

 **NOTE:** When contacting Dell support, have your Service Tag ready. The Service Tag for your computer is located at the top of each test screen.

The following tabs provide additional information for tests run from the Custom Test or Symptom Tree option:

Tab	Function
Results	Displays the results of the test and any error conditions encountered.
Errors	Displays error conditions encountered, error codes, and the problem description.
Help	Describes the test and any requirements for running the test.
Configuration	Displays the hardware configuration for the selected device. The Dell Diagnostics obtains configuration information for all devices from the system setup program, memory, and various internal tests, and displays the information in the device list in the left pane of the screen. NOTE: The device list may not display the names of all components installed on your computer or all devices attached to your computer.
Parameters	Allows you to customize the test, if applicable, by changing the test settings.

Troubleshooting Tips

- If you added or removed a part before the problem started, review the installation procedures and ensure that the part is correctly installed.
- If a peripheral device does not work, ensure that the device is properly connected.
- If an error message appears on the screen, write down the exact message. This message may help support personnel diagnose and fix the problem(s).
- If an error message occurs in a program, see the program's documentation.



NOTE: The procedures in this document were written for the Windows default view, so they may not apply if you set your Dell computer to the Windows Classic view.

Power Problems



CAUTION: Before you begin any of the procedures in this section, read and follow the safety instructions provided with your computer.

IF THE POWER LIGHT IS OFF — The computer is either turned off or is not receiving power.

- Reseat the power cable in the power connector on the back of the computer and the electrical outlet.
- Bypass power strips, power extension cables, and other power protection devices to verify that the computer turns on properly.
- Ensure that any power strips being used are plugged into an electrical outlet and are turned on.
- Ensure that the electrical outlet is working by testing it with another device, such as a lamp.
- Ensure that the main power cable and front panel cable are securely connected to the system board (see your *Service Manual* on the Dell Support website at support.dell.com).

IF THE POWER LIGHT IS BLUE AND THE COMPUTER IS NOT RESPONDING —

- Ensure that the display is connected and powered on.
- If the display is connected and powered on, see "System Messages" on page 37.

IF THE POWER LIGHT IS BLINKING BLUE — The computer is in standby mode. Press a key on the keyboard, move the mouse, or press the power button to resume normal operation.

IF THE POWER LIGHT IS BLINKING AMBER — The computer is receiving electrical power, a device might be malfunctioning or incorrectly installed.

- Remove and then reinstall all memory modules (see your *Service Manual* on the Dell Support website at support.dell.com).
- Remove and then reinstall any expansion cards, including graphics cards (see your *Service Manual* on the Dell Support website at support.dell.com).

IF THE POWER LIGHT IS STEADY AMBER — There is a power problem, a device may be malfunctioning or incorrectly installed.

- Ensure that the processor power cable is securely connected to the system board power connector (see your *Service Manual* on the Dell Support website at support.dell.com).
- Ensure that the main power cable and the front panel cable are securely connected to the system board connector (see your *Service Manual* on the Dell Support website at support.dell.com).

ELIMINATE INTERFERENCE — Some possible causes of interference are:

- Power, keyboard, and mouse extension cables
- Too many devices connected to the same power strip
- Multiple power strips connected to the same electrical outlet

Memory Problems



CAUTION: Before you begin any of the procedures in this section, read and follow the safety instructions provided with your computer.

IF YOU RECEIVE AN INSUFFICIENT MEMORY MESSAGE —

- Save and close any open files and exit any open programs you are not using to see if that resolves the problem.
- See the software documentation for minimum memory requirements. If necessary, install additional memory (see your *Service Manual* on the Dell Support website at support.dell.com).
- Reseat the memory modules (see your *Service Manual* on the Dell Support website at support.dell.com) to ensure that your computer is successfully communicating with the memory.
- Run the Dell Diagnostics (see "Dell Diagnostics" on page 39).

IF YOU EXPERIENCE OTHER MEMORY PROBLEMS —

- Reseat the memory modules (see your *Service Manual* on the Dell Support website at support.dell.com) to ensure that your computer is successfully communicating with the memory.
- Ensure that you are following the memory installation guidelines (see your *Service Manual* on the Dell Support website at support.dell.com).

- Ensure that the memory you are using is supported by your computer. For more information about the type of memory supported by your computer, see "Memory" on page 20.
- Run the Dell Diagnostics (see "Dell Diagnostics" on page 39).

Lockups and Software Problems



CAUTION: Before you begin any of the procedures in this section, read and follow the safety instructions provided with your computer.

The computer does not start up

ENSURE THAT THE POWER CABLE IS FIRMLY CONNECTED TO THE COMPUTER AND TO THE ELECTRICAL OUTLET

The computer stops responding



NOTICE: You may lose data if you are unable to perform an operating system shutdown.

TURN THE COMPUTER OFF — If you are unable to get a response by pressing a key on your keyboard or moving your mouse, press and hold the power button for at least 8 to 10 seconds (until the computer turns off), and then restart your computer.

A program stops responding

END THE PROGRAM —

- 1 Press <Ctrl><Shift><Esc> simultaneously to access the Task Manager.
- 2 Click the **Applications** tab.
- 3 Click to select the program that is no longer responding.
- 4 Click **End Task**.

A program crashes repeatedly



NOTE: Most software includes installation instructions in its documentation or on a CD or DVD.

CHECK THE SOFTWARE DOCUMENTATION — If necessary, uninstall and then reinstall the program.

A program is designed for an earlier Windows operating system

RUN THE PROGRAM COMPATIBILITY WIZARD —

Windows Vista:

The Program Compatibility Wizard configures a program so that it runs in an environment similar to non-Windows Vista operating system environments.

- 1 Click **Start**  → **Control Panel** → **Programs** → **Use an older program with this version of Windows**.
- 2 In the welcome screen, click **Next**.
- 3 Follow the instructions on the screen.

Windows XP:

The Program Compatibility Wizard configures a program so that it runs in an environment similar to non-Windows XP operating system environments.

- 1 Click **Start** → **All Programs** → **Accessories** → **Program Compatibility Wizard** → **Next**.
- 2 Follow the instructions on the screen.

A solid blue screen appears

TURN THE COMPUTER OFF — If you are unable to get a response by pressing a key on your keyboard or moving your mouse, press and hold the power button for at least 8 to 10 seconds (until the computer turns off), and then restart your computer.

Other software problems

CHECK THE SOFTWARE DOCUMENTATION OR CONTACT THE SOFTWARE MANUFACTURER FOR TROUBLESHOOTING INFORMATION —

- Ensure that the program is compatible with the operating system installed on your computer.
- Ensure that your computer meets the minimum hardware requirements needed to run the software. See the software documentation for information.
- Ensure that the program is installed and configured properly.
- Verify that the device drivers do not conflict with the program.
- If necessary, uninstall and then reinstall the program.

BACK UP YOUR FILES IMMEDIATELY —

- Use a virus-scanning program to check the hard drive, CDs, or DVDs
- Save and close any open files or programs and shut down your computer through the Start menu

Dell Technical Update Service

The Dell Technical Update service provides proactive e-mail notification of software and hardware updates for your computer. The service is free and can be customized for content, format, and how frequently you receive notifications.

To enroll for the Dell Technical Update service, go to support.dell.com/technicalupdate.

Dell Support Utility

The Dell Support Utility is installed on your computer and available from the Dell Support,  icon on the taskbar or from the **Start** button. Use this support utility for self-support information, software updates, and health scans of your computing environment.

Accessing the Dell Support Utility

Access the Dell Support Utility from the  icon on the taskbar or from the **Start** menu.

If the Dell Support icon does not appear in your taskbar:

- 1** Click **Start**→ **All Programs**→ **Dell Support**→ **Dell Support Settings**.
- 2** Ensure that the **Show icon on the taskbar** option is checked.

 **NOTE:** If the Dell Support Utility is not available from the **Start** menu, go to support.dell.com and download the software.

The Dell Support Utility is customized for your computing environment.

The  icon in the taskbar functions differently when you click, double-click, or right-click the icon.

Clicking the Dell Support Icon

Click or right-click the  icon to perform the following tasks:

- Check your computing environment.
- View the Dell Support Utility settings.
- Access the help file for the Dell Support Utility.
- View frequently asked questions.
- Learn more about the Dell Support Utility.
- Turn the Dell Support Utility off.

Double-Clicking the Dell Support Icon

Double-click the  icon to manually check your computing environment, view frequently asked questions, access the help file for the Dell Support Utility, and view Dell Support settings.

For more information about the Dell Support Utility, click the question mark (?) at the top of the **Dell™ Support** screen.

Reinstalling Software

Drivers

Identifying Drivers

If you experience a problem with any device, identify whether the driver is the source of your problem and, if necessary, update the driver.

Microsoft Windows Vista

- 1 Click the Windows Vista start button , and right-click **Computer**.
- 2 Click **Properties**, and then click **Device Manager**.



NOTE: The **User Account Control** window may appear. If you are an administrator on the computer, click **Continue**; otherwise, contact your administrator to continue.

- 3 Scroll down the list of devices and check for an exclamation point (a circle with a [!]) next to the device name.

If an exclamation point appears next to the device name, you may need to reinstall the driver or install a new driver (see "Reinstalling Drivers and Utilities" on page 52).

Microsoft Windows XP

- 1 Click **Start**→**Control Panel**.
- 2 Under **Pick a Category**, click **Performance and Maintenance**.
- 3 Click **System**.
- 4 In the **System Properties** window, click the **Hardware** tab.
- 5 Click **Device Manager**.

- 6 Scroll down the list of devices and check for an exclamation point (a circle with a [!]) next to the device name.

If an exclamation point appears next to the device name, you may need to reinstall the driver or install a new driver (see "Reinstalling Drivers and Utilities" on page 52).

Reinstalling Drivers and Utilities

-  **NOTICE:** The Dell Support website at support.dell.com and your *Drivers and Utilities* media provide approved drivers for your Dell computer. If you install drivers obtained from other sources, your computer may not function properly.

Returning to a Previous Device Driver Version

If a problem occurs on your computer after you install or update a driver, use Windows Device Driver Rollback to replace the driver with the previously installed version.

Windows Vista:

- 1 Click the Windows Vista start button , and right-click **Computer**.
- 2 Click **Properties**, and click **Device Manager**.

 **NOTE:** The **User Account Control** window may appear. If you are an administrator on the computer, click **Continue**; otherwise, contact your administrator to continue.

- 3 Right-click the device for which the new driver was installed, and click **Properties**.
- 4 Click the **Driver** tab.
- 5 Click **Roll Back Driver**.

If Device Driver Rollback does not resolve the problem, reinstall the driver from the *Drivers and Utilities* media.

Windows XP:

- 1 Click **Start** → **Control Panel**.
- 2 Under **Pick a Category**, click **Performance and Maintenance**.
- 3 Click **System**.
- 4 In the **System Properties** window, click the **Hardware** tab.
- 5 Click **Device Manager**.

- 6 Right-click the device for which the new driver was installed, and click **Properties**.
- 7 Click the **Driver** tab.
- 8 Click **Roll Back Driver**.

If Device Driver Rollback does not resolve the problem, reinstall the driver from the *Drivers and Utilities* media.

Using the Drivers and Utilities Disc

If a problem occurs on your computer after you install or update a driver and Device Driver Rollback does not resolve the problem, reinstall the driver from the *Drivers and Utilities* media.

- 1 Save and close any open files, and exit any open programs.
- 2 Insert the *Drivers and Utilities* media.

In most cases, the CD/DVD starts running automatically. If it does not, start Windows Explorer, click your CD/DVD drive directory to display the CD/DVD contents, and then double-click the **autorcd.exe** file. The first time that you run the CD/DVD, it may prompt you to install setup files. Click **OK**, and then follow the instructions on the screen.

- 3 From the **Language** drop-down menu in the toolbar, select your preferred language for the driver or utility (if available).
- 4 At the welcome screen, click **Next** and wait for the CD/DVD to complete the hardware scan.
- 5 To detect other drivers and utilities, under **Search Criteria**, select the appropriate categories from the **System Model**, **Operating System**, and **Topic** drop-down menus.

A link or links appear(s) for the specific drivers and utilities used by your computer.

- 6 Click the link of a specific driver or utility to display information about the driver or utility that you want to install.
- 7 Click the **Install** button (if present) to begin installing the driver or utility. At the welcome screen, follow the screen prompts to complete the installation.

If no **Install** button is present, automatic installation is not an option. For installation instructions, either see the appropriate instructions in the



following subsections, or click **Extract**, follow the extracting instructions, and then read the readme file.

If instructed to navigate to the driver files, click the CD/DVD directory on the driver information window to display the files associated with that driver.

Manually Reinstalling Drivers

After extracting the driver files to your hard drive as described in the previous section you may be required to update the driver manually.

Microsoft Windows Vista:

- 1 Click the Windows Vista start button , and right-click **Computer**.
- 2 Click **Properties**, and click **Device Manager**.
 **NOTE:** The **User Account Control** window may appear. If you are an administrator on the computer, click **Continue**; otherwise, contact your administrator to continue.
- 3 Double-click the type of device for which you are installing the driver.
- 4 Double-click the name of the device for which you are installing the driver.
- 5 Click the **Driver** tab.
- 6 Click **Update Driver**.
- 7 Click **Browse my computer for driver software**.
- 8 Click **Browse** and navigate to where the driver files are located on your hard drive.
- 9 When the name of the appropriate driver appears, click the name of the driver, and click **OK**.
- 10 Click **Next**.
- 11 Click **Finish** and restart your computer.

Microsoft Windows XP:

- 
- NOTE:**
- Drivers can be manually updated for any hardware device installed in your computer.
- 1 Click **Start**→ **Control Panel**.
 - 2 Under **Pick a Category**, click **Performance and Maintenance**.
 - 3 Click **System**.

- 4 In the **System Properties** window, click the **Hardware** tab.
- 5 Click **Device Manager**.
- 6 Double-click the type of device for which you are installing the driver.
- 7 Right-click the device for which the driver is being reinstalled, and click **Properties**.
- 8 Click the **Driver** tab.
- 9 Click **Update Driver**.
- 10 Click **Install from a list or specific location (Advanced)**, and click **Next**.
- 11 Click to check **Include this location in the search**, and click **Browse** and navigate to where the driver files are located on your hard drive.
- 12 When the name of the appropriate driver appears, click **OK**.
- 13 Click **Next**.
- 14 Click **Finish** and restart your computer.

Restoring Your Operating System

You can restore your operating system in the following ways:

- System Restore returns your computer to an earlier operating state without affecting data files. Use System Restore as the first solution for restoring your operating system and preserving data files.
- Dell PC Restore by Symantec (available in Windows XP) and Dell Factory Image Restore (available in Windows Vista) returns your hard drive to the operating state it was in when you purchased the computer. Both permanently delete all data on the hard drive and remove any programs installed after you received the computer. Use Dell PC Restore or Dell Factory Image Restore only if System Restore did not resolve your operating system problem.
- *Operating System* installation media can be used to perform a reinstall of your operating system. However, using the *Operating System* installation media also deletes all data on the hard drive. Use the media *only* if System Restore did not resolve your operating system problem.

Using Microsoft Windows System Restore



The Windows operating systems provide a System Restore option which allows you to return your computer to an earlier operating state (without affecting data files). Using System Restore can be helpful if changes to the system hardware, software, or settings have left the computer in an undesirable operating state. For information on using System Restore, see the Windows Help and Support Center (click **Start**, and click **Help and Support**).



NOTICE: System Restore does not monitor your data files or recover them. Make regular backups of your data files.

Starting System Restore

Microsoft Windows Vista:

- 1 Click **Start** .
- 2 In the Start Search box, type **System Restore** and press <Enter>.
 **NOTE:** The **User Account Control** window may appear. If you are an administrator on the computer, click **Continue**; otherwise, contact your administrator to continue.
- 3 Click **Next** and follow the instructions on the screen.

Microsoft Windows XP:



NOTICE: Before you restore the computer to an earlier operating state, save and close any open files and exit any open programs. Do not alter, open, or delete any files or programs until the system restoration process is complete.



NOTE: If a problem occurs after you install a device driver, first try to resolve the problem by using Windows XP Device Driver Rollback (see "Returning to a Previous Device Driver Version" on page 52), or reinstall the driver with the *Drivers and Utilities* media (see "Using the Drivers and Utilities Disc" on page 53).

- 1 Click **Start**→ **All Programs**→ **Accessories**→ **System Tools**→ **System Restore**.
- 2 Click either **Restore my computer to an earlier time** or **Create a restore point**.
- 3 Click **Next** and follow the instructions on the screen.

Undoing the Last System Restore

-  **NOTICE:** Before you undo the last system restore, save and close all open files and exit any open programs. Do not alter, open, or delete any files or programs until the system restoration process is complete.

Microsoft Windows Vista:

- 1 Click Start .
- 2 In the Start Search box, type `System Restore` and press <Enter>.
- 3 Click **Undo my last restoration** and click **Next**.

Microsoft Windows XP:

- 1 Click Start → All Programs → Accessories → System Tools → System Restore.
- 2 Click **Undo my last restoration** and click **Next**.

Enabling System Restore

-  **NOTE:** Windows Vista does not disable System Restore; regardless of low disk space. Therefore, the following steps apply only to Windows XP.

If you reinstall Windows XP with less than 200 MB of free hard-disk space available, System Restore is automatically disabled.

To see if System Restore is enabled:

- 1 Click Start → Control Panel → Performance and Maintenance → System.
- 2 Click the **System Restore** tab and ensure that **Turn off System Restore** is unchecked.

Using Dell Factory Image Restore and Dell PC Restore

-  **NOTICE:** Using Dell Factory Image Restore or Dell PC Restore permanently deletes all data on the hard drive and removes any programs or drivers installed after you received your computer. If possible, back up the data before using these options. Use Dell Factory Image Restore or PC Restore only if System Restore did not resolve your operating system problem.

-  **NOTE:** Dell Factory Image Restore and Dell PC Restore by Symantec may not be available in certain countries or on certain computers.

Use Dell Factory Image Restore (Windows Vista) or Dell PC Restore (Windows XP) only as the last method to restore your operating system. These options restore your hard drive to the operating state it was in when

you purchased the computer. Any programs or files added since you received your computer—including data files—are permanently deleted from the hard drive. Data files include documents, spreadsheets, e-mail messages, digital photos, music files, and so on. If possible, back up all data before using Factory Image Restore or PC Restore.

Dell Factory Image Restore (Microsoft Windows Vista)

- 1 Turn on the computer. When the DELL logo appears, press <F8> several times to access the **Vista Advanced Boot Options** window.
- 2 Select **Repair Your Computer**.
The **System Recovery Options** window appears.
- 3 Select a keyboard layout and click **Next**.
- 4 To access the recovery options, log on as a local user. To access the command prompt, type `administrator` in the User name field, and click **OK**.
- 5 Click **Dell Factory Image Restore**.



NOTE: Depending upon your configuration, you may need to select **Dell Factory Tools**, and then **Dell Factory Image Restore**.

The Dell Factory Image Restore welcome screen appears.

- 6 Click **Next**.

The Confirm Data Deletion screen appears.



NOTICE: If you do not want to proceed with Factory Image Restore, click **Cancel**.

- 7 Click the check box to confirm that you want to continue reformatting the hard drive and restoring the system software to the factory condition, and then click **Next**.

The restore process begins and may take five or more minutes to complete. A message appears when the operating system and factory-installed applications have been restored to factory condition.

- 8 Click **Finish** to reboot the system.

Dell PC Restore (Microsoft Windows XP)

- 1 Turn on the computer.

During the boot process, a blue bar with **www.dell.com** appears at the top of the screen.

- 2 Immediately upon seeing the blue bar, press <Ctrl><F11>.

If you do not press <Ctrl><F11> in time, let the computer finish starting, and then restart the computer again.



NOTICE: If you do not want to proceed with PC Restore, click **Reboot**.

- 3 Click **Restore** and click **Confirm**.

The restore process takes approximately 6 to 10 minutes to complete.

- 4 When prompted, click **Finish** to reboot the computer.



NOTE: Do not manually shut down the computer. Click **Finish** and let the computer completely reboot.

- 5 When prompted, click **Yes**.

The computer restarts. Because the computer is restored to its original operating state, the screens that appear, such as the End User License Agreement, are the same ones that appeared the first time the computer was turned on.

- 6 Click **Next**.

The **System Restore** screen appears and the computer restarts.

- 7 After the computer restarts, click **OK**.

Removing PC Restore



NOTICE: Removing Dell PC Restore from the hard drive permanently deletes the PC Restore utility from your computer. After you have removed Dell PC Restore, you will not be able to use it to restore your computer operating system.

Dell PC Restore enables you to restore your hard drive to the operating state it was in when you purchased your computer. It is recommended that you *do not* remove PC Restore from your computer, even to gain additional hard-drive space. If you remove PC Restore from the hard drive, you cannot ever recall it, and you will never be able to use PC Restore to return your computer operating system to its original state.

- 1 Log on to the computer as a local administrator.
- 2 In Microsoft Windows Explorer, go to `c:\dell\utilities\DSR`.
- 3 Double-click the filename `DSRIRRemv2.exe`.



NOTE: If you do not log on as a local administrator, a message appears stating that you that you must log on as administrator. Click **Quit**, and then log on as a local administrator.



NOTE: If the partition for PC Restore does not exist on your computer hard drive, a message appears stating that the partition was not found. Click **Quit**; there is no partition to delete.

- 4 Click **OK** to remove the PC Restore partition on the hard drive.
- 5 Click **Yes** when a confirmation message appears.
The PC Restore partition is deleted and the newly available disk space is added to the free space allocation on the hard drive.
- 6 Right-click **Local Disk (C)** in Windows Explorer, click **Properties**, and verify that the additional disk space is available as indicated by the increased value for **Free Space**.
- 7 Click **Finish** to close the **PC Restore Removal** window and restart the computer.

Using the Operating System Media

Before you Begin

If you are considering reinstalling the Windows operating system to correct a problem with a newly installed driver, first try using Windows Device Driver Rollback (see "Returning to a Previous Device Driver Version" on page 52). If Device Driver Rollback does not resolve the problem, then use System Restore to return your operating system to the operating state it was in before you installed the new device driver (see "Using Microsoft Windows System Restore" on page 56).

-  **NOTICE:** Before performing the installation, back up all data files on your primary hard drive. For conventional hard drive configurations, the primary hard drive is the first drive detected by the computer.

To reinstall Windows, you need the following items:

- Dell *Operating System* media
- Dell *Drivers and Utilities* media

-  **NOTE:** The Dell *Drivers and Utilities* media contains drivers that were installed during the assembly of the computer. Use the Dell *Drivers and Utilities* media to load any required drivers. Depending on the region from which you ordered your computer, or whether you requested the media, the Dell *Drivers and Utilities* media and *Operating System* media may not ship with your computer.

Reinstalling Windows Vista or Windows XP

The reinstallation process can take 1 to 2 hours to complete. After you reinstall the operating system, you must also reinstall the device drivers, virus protection program, and other software.

- 1 Save and close any open files and exit any open programs.
- 2 Insert the *Operating System* disc.
- 3 If the **Install Windows** message appears, click **Exit**.
- 4 Restart the computer.

When the DELL logo appears, press <F12> immediately.

-  **NOTE:** If you wait too long and the operating system logo appears, continue to wait until you see the Microsoft® Windows® desktop; then, shut down your computer and try again.

-  **NOTE:** The next steps change the boot sequence for one time only. On the next start-up, the computer boots according to the devices specified in the system setup program.

- 5 When the boot device list appears, highlight **CD/DVD/CD-RW Drive** and press <Enter>.
- 6 Press any key to **Boot from CD-ROM**.
- 7 Follow the instructions on the screen to complete the installation.

Finding Information



NOTE: Some features or media may be optional and may not ship with your computer. Some features or media may not be available in certain countries.



NOTE: Additional information may ship with your computer.

Document/Media/Label	Contents
<p>Service Tag/Express Service Code</p> <p>Your Service Tag/Express Service Code is located on your computer.</p>	<ul style="list-style-type: none"> • Use the Service Tag to identify your computer when you use support.dell.com or contact support. • Enter the Express Service Code to direct your call when contacting support.
<p>Drivers and Utilities Media</p> <p>The <i>Drivers and Utilities</i> media is a CD or DVD that may have shipped with your computer.</p>	<ul style="list-style-type: none"> • A diagnostic program for your computer • Drivers for your computer <p>NOTE: Drivers and documentation updates can be found at support.dell.com.</p> <ul style="list-style-type: none"> • Desktop System Software (DSS) • Readme files <p>NOTE: Readme files may be included on your media to provide last-minute updates about technical changes to your computer or advanced technical-reference material for technicians or experienced users.</p>
<p>Operating System Media</p> <p>The <i>Operating System</i> media is a CD or DVD that may have shipped with your computer.</p>	<p>Reinstall your operating system</p>

Document/Media/Label	Contents
<p>Safety, Regulatory, Warranty, and Support Documentation</p> <p>See the safety and warranty information that shipped with your computer.</p> <p>For additional regulatory information, see the Regulatory Compliance homepage on www.dell.com at the following location: www.dell.com/regulatory_compliance.</p>	<ul style="list-style-type: none"> • Warranty information • Terms and Conditions (U.S. only) • Safety instructions • Regulatory information • Ergonomics information • End User License Agreement
<p>Service Manual</p> <p>The <i>Service Manual</i> for your computer is available at support.dell.com.</p>	<ul style="list-style-type: none"> • How to remove and replace parts • How to configure system settings • How to troubleshoot and solve problems
<p>Dell Technology Guide</p> <p>The <i>Dell Technology Guide</i> is available at support.dell.com.</p>	<ul style="list-style-type: none"> • About your operating system • Using and maintaining peripherals • Understanding technologies such as RAID, Internet, Bluetooth[®] wireless technology, e-mail, networking, and more
<p>Microsoft[®] Windows[®] Product Key</p> <p>Your Microsoft Windows License is located on your computer.</p>	<ul style="list-style-type: none"> • Provides the product key for your operating system. <p>NOTE: Your Microsoft Windows product key is located on your computer.</p>

Getting Help

Obtaining Assistance

 **CAUTION:** If you need to remove the computer cover, first disconnect the computer power and modem cables from all electrical outlets.

If you experience a problem with your computer, you can complete the following steps to diagnose and troubleshoot the problem:

- 1 See "Troubleshooting Tips" on page 44 for information and procedures that pertain to the problem your computer is experiencing.
- 2 See "Troubleshooting Tips" on page 44 for procedures on how to run Dell Diagnostics.
- 3 Fill out the "Diagnostics Checklist" on page 70.
- 4 Use Dell's extensive suite of online services available at Dell Support (support.dell.com) for help with installation and troubleshooting procedures. See "Online Services" on page 66 for a more extensive list of Dell Support online.
- 5 If the preceding steps have not resolved the problem, see "Contacting Dell" on page 71.



NOTE: Call Dell Support from a telephone at or near the affected computer so that the support staff can assist you with any necessary procedures.



NOTE: Dell's Express Service Code system may not be available in all countries.

When prompted by Dell's automated telephone system, enter your Express Service Code to route the call directly to the proper support personnel. If you do not have an Express Service Code, open the **Dell Accessories** folder, double-click the **Express Service Code** icon, and follow the directions.

For instructions on using the Dell Support, see "Technical Support and Customer Service" on page 66.



NOTE: Some of the following services are not always available in all locations outside the continental U.S. Call your local Dell representative for information on availability.

Technical Support and Customer Service

Dell's support service is available to answer your questions about Dell hardware. Our support staff uses computer-based diagnostics to provide fast, accurate answers.

To contact Dell's support service, see "Before You Call" on page 69, and then see the contact information for your region or go to support.dell.com.

DellConnect™

DellConnect is a simple online access tool that allows a Dell service and support associate to access your computer through a broadband connection, diagnose your problem and repair it all under your supervision. For more information, go to support.dell.com and click **DellConnect**.

Online Services

You can learn about Dell products and services at the following websites:

www.dell.com

www.dell.com/ap (Asian/Pacific countries only)

www.dell.com/jp (Japan only)

www.euro.dell.com (Europe only)

www.dell.com/la (Latin American and Caribbean countries)

www.dell.ca (Canada only)

You can access Dell Support through the following websites and e-mail addresses:

- Dell Support websites
support.dell.com
support.jp.dell.com (Japan only)
support.euro.dell.com (Europe only)

- Dell Support e-mail addresses
mobile_support@us.dell.com
support@us.dell.com
la-techsupport@dell.com (Latin America and Caribbean countries only)
apsupport@dell.com (Asian/Pacific countries only)
- Dell Marketing and Sales e-mail addresses
apmarketing@dell.com (Asian/Pacific countries only)
sales_canada@dell.com (Canada only)
- Anonymous file transfer protocol (FTP)
ftp.dell.com
Log in as user: anonymous, and use your e-mail address as your password.

AutoTech Service

Dell's automated support service—AutoTech—provides recorded answers to the questions most frequently asked by Dell customers about their portable and desktop computers.

When you call AutoTech, use your touch-tone telephone to select the subjects that correspond to your questions. For the telephone number to call for your region, see "Contacting Dell" on page 71.

Automated Order-Status Service

To check on the status of any Dell products that you have ordered, you can go to support.dell.com, or you can call the automated order status service. A recording prompts you for the information needed to locate and report on your order. For the telephone number to call for your region, see "Contacting Dell" on page 71.

Problems With Your Order

If you have a problem with your order, such as missing parts, wrong parts, or incorrect billing, contact Dell for customer assistance. Have your invoice or packing slip available when you call. For the telephone number to call for your region, see "Contacting Dell" on page 71.

Product Information

If you need information about additional products available from Dell, or if you would like to place an order, visit the Dell website at www.dell.com. For the telephone number to call for your region or to speak to a sales specialist, see "Contacting Dell" on page 71.

Returning Items for Warranty Repair or Credit

Prepare all items being returned, whether for repair or credit, as follows:

- 1** Call Dell to obtain a Return Material Authorization Number, and write the number clearly and prominently on the outside of the box.
For the telephone number to call for your region, see "Contacting Dell" on page 71.
- 2** Include a copy of the invoice and a letter describing the reason for the return.
- 3** Include a copy of the Diagnostics Checklist (see "Diagnostics Checklist" on page 70), indicating the tests that you have run and any error messages reported by the Dell Diagnostics (see "Troubleshooting Tips" on page 44).
- 4** Include any accessories that belong with the item(s) being returned (power cables, software media, guides, and so on) if the return is for credit.
- 5** Pack the equipment to be returned in the original (or equivalent) packing materials.

You are responsible for paying shipping expenses. You are also responsible for insuring any product returned, and you assume the risk of loss during shipment to Dell. Collect On Delivery (C.O.D.) packages are not accepted.

Returns that are missing any of the preceding requirements will be refused at Dell's receiving dock and returned to you.

Before You Call



NOTE: Have your Express Service Code ready when you call. The code helps Dell's automated-support telephone system direct your call more efficiently. You may also be asked for your Service Tag (located on the back or bottom of your computer).

Remember to fill out the Diagnostics Checklist (see "Diagnostics Checklist" on page 70). If possible, turn on your computer before you call Dell for assistance and call from a telephone at or near the computer. You may be asked to type some commands at the keyboard, relay detailed information during operations, or try other troubleshooting steps possible only at the computer itself. Ensure that the computer documentation is available.



CAUTION: Before working inside your computer, read and follow the safety instructions provided with your computer.

Diagnostics Checklist

Name:

Date:

Address:

Phone number:

Service Tag (bar code on the back or bottom of the computer):

Express Service Code:

Return Material Authorization Number (if provided by Dell support technician):

Operating system and version:

Devices:

Expansion cards:

Are you connected to a network? Yes No

Network, version, and network adapter:

Programs and versions:

See your operating system documentation to determine the contents of the system's start-up files. If the computer is connected to a printer, print each file. Otherwise, record the contents of each file before calling Dell.

Error message, beep code, or diagnostic code:

Description of problem and troubleshooting procedures you performed:

Contacting Dell

For customers in the United States, call 800-WWW-DELL (800-999-3355).



NOTE: If you do not have an active Internet connection, you can find contact information on your purchase invoice, packing slip, bill, or Dell product catalog.

Dell provides several online and telephone-based support and service options. Availability varies by country and product, and some services may not be available in your area. To contact Dell for sales, technical support, or customer service issues:

- 1 Visit support.dell.com.
- 2 Verify your country or region in the **Choose A Country/Region** drop-down menu at the bottom of the page.
- 3 Click **Contact Us** on the left side of the page.
- 4 Select the appropriate service or support link based on your need.
- 5 Choose the method of contacting Dell that is convenient for you.

Index

B

beep codes, 30

C

CDs

operating system, 63

computer

beep codes, 30

crashes, 47-48

restore to previous state, 55

stops responding, 47

conflicts

software and hardware

incompatibilities, 38

contacting Dell, 71

D

Dell

contacting, 71

DellConnect, 66

diagnostics

beep codes, 30

documentation

User's Guide, 64

drivers, 51

identifying, 51

reinstalling, 52

E

ergonomics information, 64

error messages

beep codes, 30

F

Factory Image Restore, 58

Files and Settings Transfer
Wizard, 15

H

hardware

beep codes, 30

conflicts, 38

Hardware Troubleshooter, 38

I

- Internet connection
 - about, 13
 - options, 13
 - setting up, 13
- IRQ conflicts, 38

M

- memory
 - problems, 46

O

- operating system
 - media, 60
 - reinstalling, 63

P

- PC Restore, 57, 59
- phone numbers, 71
- power
 - problems, 45
- power light, 49
 - conditions, 45
- printer
 - connecting, 13
 - setting up, 13

problems

- beep codes, 30
- blue screen, 48
- computer crashes, 47-48
- computer stops responding, 47
- conflicts, 38
- general, 47
- memory, 46
- power, 45
- power light conditions, 45
- program crashes, 47
- program stops responding, 47
- restore to previous state, 55-56
- software, 47-48

S

- S.M.A.R.T., 38
- software
 - conflicts, 38
 - problems, 47-48
- specifications
 - audio, 21
 - computer information, 19
 - connectors, 22
 - controls and lights, 24
 - drives, 20
 - environmental, 26
 - expansion bus, 21
 - memory, 20
 - physical, 26
 - power, 25
 - processor, 19
 - video, 20

support
 contacting Dell, 71
System Restore, 55-56

T

telephone numbers, 71
transferring information to a new
 computer, 15
troubleshooting
 conflicts, 38
 error messages, 32
 Hardware Troubleshooter, 38
 restore to previous state, 55-56

W

Windows Vista
 Dell Factory Image Restore, 57
 System Restore, 56
Windows XP
 Dell PC Restore, 57
 Device Driver Rollback, 52
 Files and Settings Transfer
 Wizard, 15
 Hardware Troubleshooter, 38
 reinstalling, 63
 System Restore, 55-56
wizards
 Files and Settings Transfer
 Wizard, 15

