

Dell™ Dimension™ 4600C

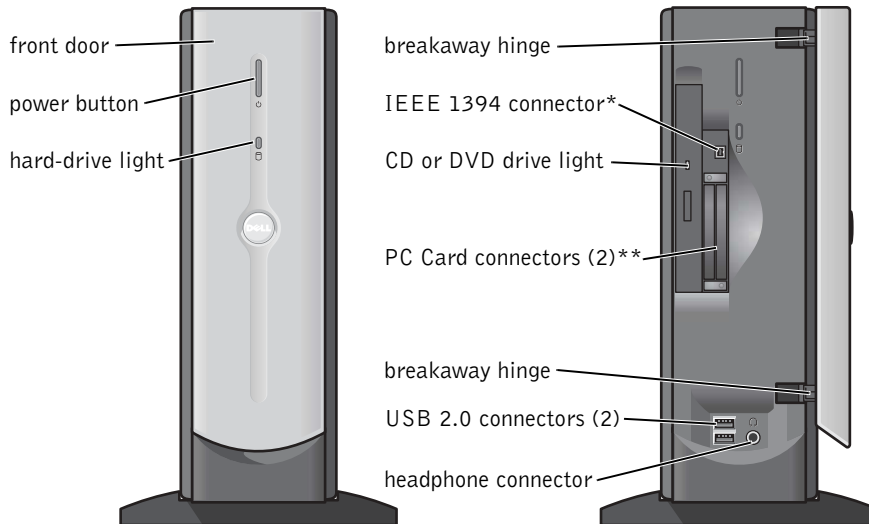

* On computers with integrated IEEE 1394 connectors.

** On computers with integrated PC Card connectors.

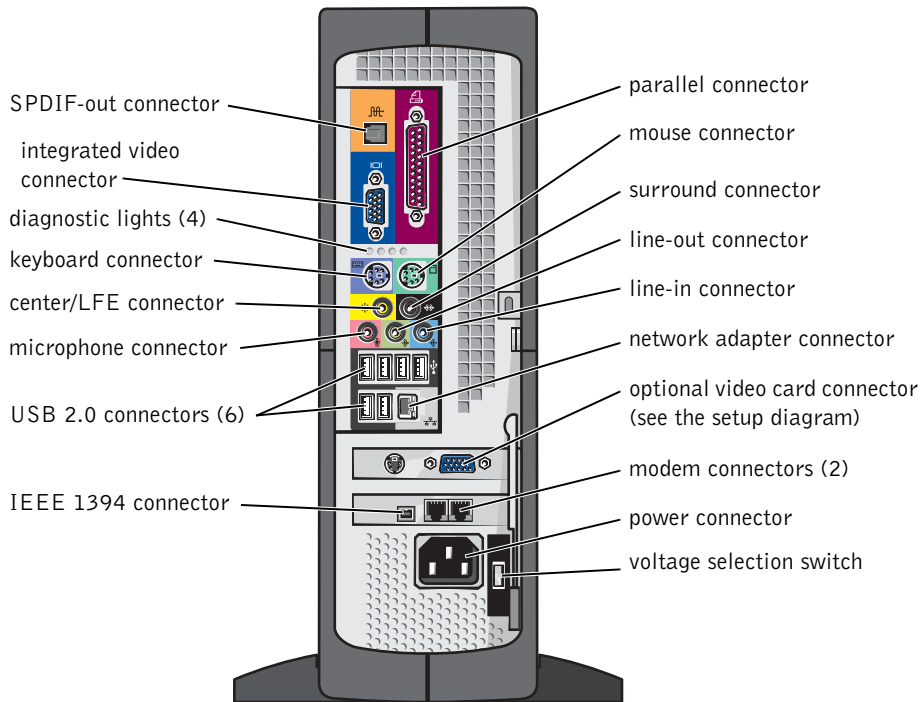

Notes, Notices, and Cautions



NOTE: A NOTE indicates important information that helps you make better use of your computer.



NOTICE: A NOTICE indicates either potential damage to hardware or loss of data and tells you how to avoid the problem.



CAUTION: A CAUTION indicates a potential for property damage, personal injury, or death.

Abbreviations and Acronyms

For a complete list of abbreviations and acronyms, see the *Tell Me How* help file. To access help files, see page 25.

Information in this document is subject to change without notice.

© 2003–2004 Dell Inc. All rights reserved.

Reproduction in any manner whatsoever without the written permission of Dell Inc. is strictly forbidden.

Trademarks used in this text: *Dell*, the *DELL* logo, *Inspiron*, *Dell Precision*, *Dimension*, *OptiPlex*, *DellNet*, *PowerApp*, *PowerVault*, *PowerEdge*, *PowerConnect*, *Axim*, and *Latitude* are trademarks of Dell Inc.; *Intel*, *Pentium*, and *Celeron* are registered trademarks of Intel Corporation; *Microsoft* and *Windows* are registered trademarks of Microsoft Corporation.

Other trademarks and trade names may be used in this document to refer to either the entities claiming the marks and names or their products. Dell Inc. disclaims any proprietary interest in trademarks and trade names other than its own.

Model DHP

July 2004

P/N H7228

Rev. A00

Contents

	Safety Instructions	7
	Finding Information for Your Computer	9
1	Setting Up and Using Your Computer	
	Connecting the AC Adapter (Japan only)	11
	Attaching and Removing the Computer Stand	12
	Setting Up a Printer	13
	Printer Cable	14
	Connecting a Parallel Printer	14
	Connecting a USB Printer	15
	Connecting an IEEE 1394 Device (Optional)	16
	Setting Up a Home and Office Network	16
	Connecting to a Network Adapter	16
	Network Setup Wizard	17
	Connecting to the Internet	18
	Setting Up Your Internet Connection	18
	Copying CDs and DVDs	19
	How to Copy a CD or DVD	19
	Using Blank CD-Rs and CD-RWs	20
	Helpful Tips	20
	Hyper-Threading	20
	Booting to a USB Device	21
	Turning Off Your Computer	21
2	Solving Problems	
	Finding Solutions	23
	Finding Help Information	25

Battery Problems	25
Drive Problems	26
CD drive problems.	26
Problems writing to a CD-RW drive.	26
DVD drive problems.	27
Hard drive problems.	27
E-Mail, Modem, and Internet Problems	27
Error Messages	29
General Problems	30
The computer stops responding	30
A program stops responding.	30
A program crashes repeatedly.	30
A program is designed for an earlier Microsoft® Windows® operating system	30
A solid blue screen appears	31
Other software problems	31
Other technical problems	32
General hardware problems	32
IEEE 1394 Device Problems	33
Keyboard Problems	33
Mouse Problems	34
Network Problems	35
PC Card Problems	35
Power Problems	36
Printer Problems	37
Scanner Problems	38
Sound and Speaker Problems	39
No sound from speakers.	39
No sound from headphones	40

Video and Monitor Problems	40
If the screen is blank	40
If the screen is difficult to read.	41

3 Advanced Troubleshooting

Diagnostic Lights	43
Dell Diagnostics	46
Starting the Dell Diagnostics.	47
Drivers	48
What Is a Driver?	48
Identifying Drivers.	48
Reinstalling Drivers	49
Restoring Your Operating System	49
Using Microsoft Windows XP System Restore	50
Using Dell PC Restore by Symantec	51
Resolving Software and Hardware Incompatibilities	52

4 Adding Parts

Front and Back View of the Computer	53
Front View	53
Back View	55
Reattaching the Front Door	57
Opening the Computer Cover	58
Looking Inside Your Computer	60
System Board	61
Adding PC Cards (Optional)	62
PC Card Types	62
Installing a PC Card	63
Removing a PC Card.	64
Adding Other Cards	65

Adding or Replacing a Video Card	66
Removing a Video Card	67
Installing a Video Card.	68
Adding Memory	68
DDR Memory Overview	68
Installing Memory.	69
Removing Memory	71
Closing the Computer Cover	72

5 Appendix

Specifications	73
Standard Settings	77
Viewing Settings	78
System Setup Screens.	78
Clearing Forgotten Passwords	78
Replacing the Battery	79
Dell Technical Support Policy (U.S. Only)	81
Definition of "Dell-Installed" Software and Peripherals	81
Definition of "Third-Party" Software and Peripherals	81
FCC Notices (U.S. Only)	82
Class A	82
Class B	82
FCC Identification Information	83
Contacting Dell	83

Index	101
-----------------	-----

Safety Instructions

See your *Product Information Guide* for safety instructions.

Finding Information for Your Computer

What are you looking for?	Find It Here
---------------------------	--------------

- How to set up my computer

Setup Diagram



- Tips on using Windows
- How to clean my computer
- How to use my mouse and keyboard

Tell Me How Help File

- 1 Click the **Start** button and click **Help and Support**.
- 2 Click **User and system guides** and click **User's guides**.
- 3 Click **Tell Me How**.

- Express Service Code and Service Tag
- Microsoft® Windows® License Label

Express Service Code and Product Key Label



These labels are located on your computer.

What are you looking for?	Find It Here
<ul style="list-style-type: none"> • Latest drivers for my computer • Answers to technical service and support questions • Online discussions with other users and technical support • Documentation for my computer 	<p data-bbox="613 432 1019 464">Dell Support Website — support.dell.com</p> <p data-bbox="613 474 1268 506">The Dell Support website provides several online tools, including:</p> <ul style="list-style-type: none"> • Solutions — Troubleshooting hints and tips, articles from technicians, and online courses • Community Forum — Online discussion with other Dell customers • Upgrades — Upgrade information for components, such as memory, the hard drive, and the operating system • Customer Care — Contact information, order status, warranty, and repair information • Downloads — Drivers, patches, and software updates • Reference — Computer documentation, product specifications, and white papers
<ul style="list-style-type: none"> • How to use Windows XP • Documentation for my computer • Documentation for devices (such as a modem) 	<p data-bbox="613 842 954 873">Windows Help and Support Center</p> <ol style="list-style-type: none"> 1 Click the Start button and click Help and Support. 2 Type a word or phrase that describes your problem and click the arrow icon. 3 Click the topic that describes your problem. 4 Follow the instructions on the screen.

Setting Up and Using Your Computer

Connecting the AC Adapter (Japan only)

⚠ CAUTION: Before you begin any of the procedures in this section, follow the safety instructions in the *Product Information Guide*.

- 1 Connect the AC adapter to the plug on the AC power cable.

⚠ CAUTION: If you decide to connect the green ground wire to an electrical outlet, *do not permit* contact between the green ground wire and power leads because electrical shock, fire, or damage to your computer can occur (see the following figure).

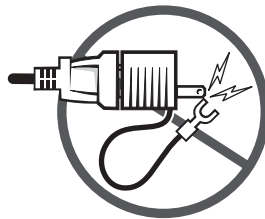

If you decide *not* to connect the green ground wire to an electrical outlet, go to step 3.

- 2 Connect the metal ground connector to the grounding source on the outlet (see the following figure):
 - a Loosen the grounding source.
 - b Slide the metal ground connector behind the grounding source, and then tighten the grounding source.

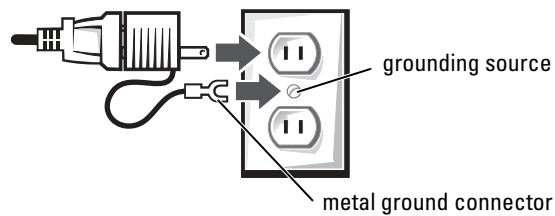

- 3 Connect the AC power cable to the outlet.

Attaching and Removing the Computer Stand

CAUTION: Before you begin any of the procedures in this section, follow the safety instructions in the *Product Information Guide*.

NOTE: Place your computer on a soft surface to prevent scratching the top cover.

To attach the stand:

- 1 Rotate the computer to an upside-down position.
- 2 Insert the screw into the bottom of the stand.
- 3 Align the two tabs and the screw on the stand with the tab holes and screw hole in the bottom of the computer.

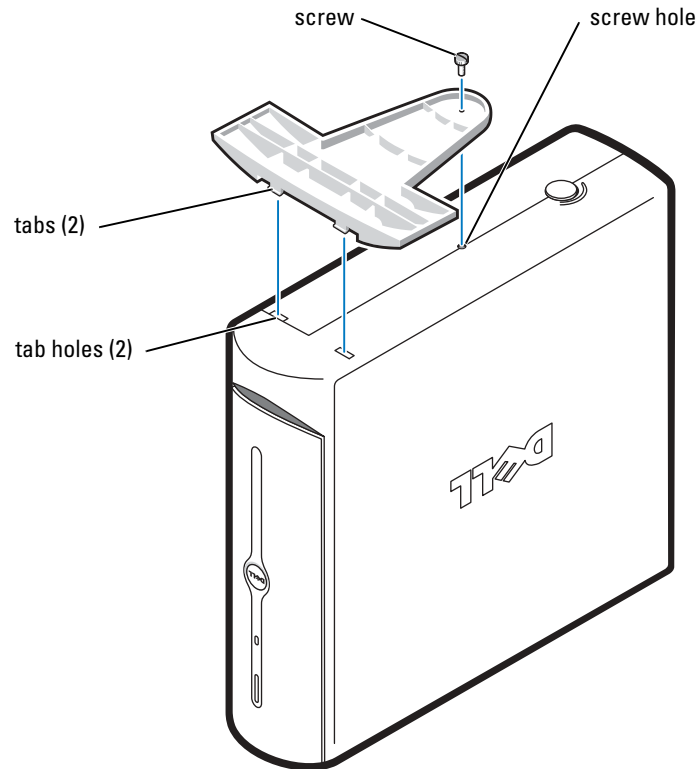

- 4 Tighten the screw.
- 5 Place the computer in the upright position.



To remove the stand:

- 1 Turn the computer over so that the stand is at the top.
- 2 Loosen the screw and lift the stand away.
- 3 Place the computer in a horizontal position until you reattach the stand.



Setting Up a Printer

NOTICE: Complete the operating system setup before you connect a printer to the computer.

See the documentation that came with the printer for setup information, including how to:

- Obtain and install updated drivers.
- Connect the printer to the computer.
- Load paper and install the toner or ink cartridge.
- Contact the printer manufacturer for technical assistance.

Printer Cable

Your printer connects to your computer with either a USB cable or a parallel cable. Your printer may not come with a printer cable, so if you purchase a cable separately, ensure that it is compatible with your printer. If you purchased a printer cable at the same time you purchased your computer, the cable may arrive in the computer box.

Connecting a Parallel Printer

⚠ CAUTION: Before you begin any of the procedures in this section, follow the safety instructions in the *Product Information Guide*.

- 1 Complete the operating system setup, if you have not already done so.
- 2 Turn off the computer (see page 21).

🔄 NOTICE: For best results, use a 3-m (10-ft) or shorter parallel cable.

- 3 Attach the parallel printer cable to the parallel connector on the computer and tighten the two screws. Attach the cable to the connector on the printer and snap the two clips into the two notches.

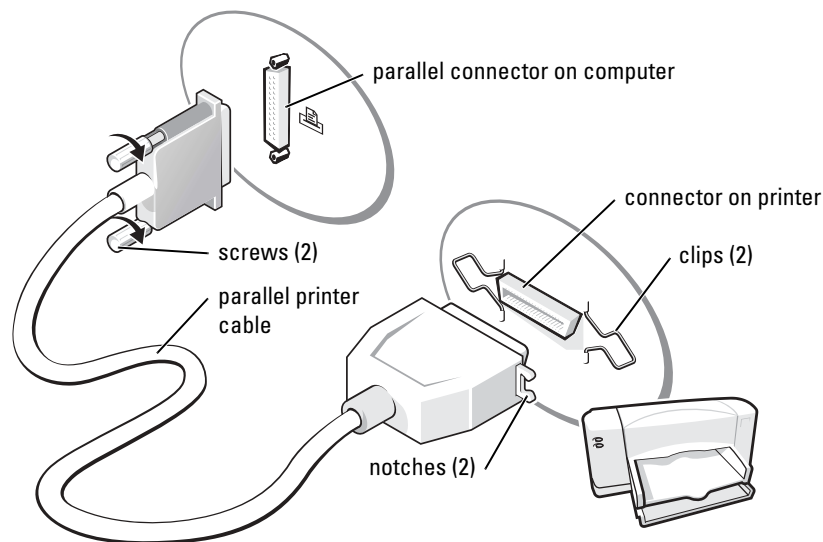

- 4 Turn on the printer and then turn on the computer. If the **Add New Hardware Wizard** window appears, click **Cancel**.
- 5 Install the printer driver if necessary. See the documentation that came with your printer.

Connecting a USB Printer

 **NOTE:** You can connect USB devices while the computer is turned on.

- 1 Complete the operating system setup if you have not already done so.
- 2 Install the printer driver if necessary. See the documentation that came with your printer.
- 3 Attach the USB printer cable to the USB connectors on the computer and the printer.
The USB connectors fit only one way.

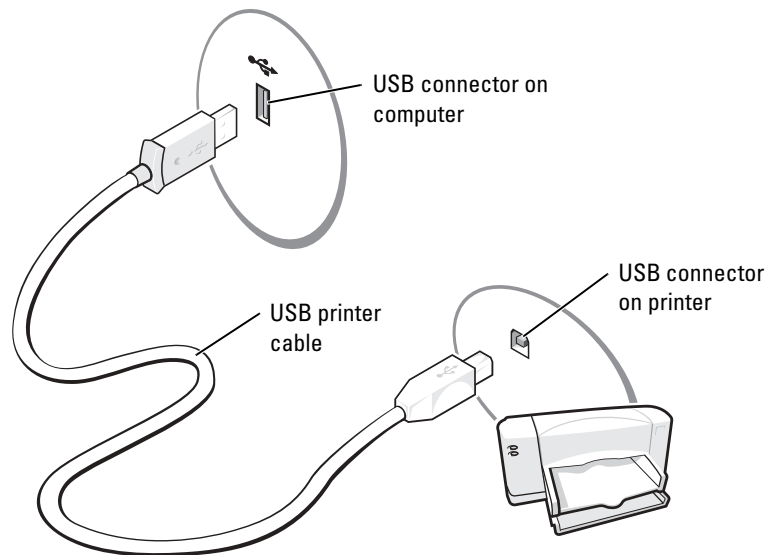

Connecting an IEEE 1394 Device (Optional)

IEEE 1394 devices can move large amounts of data between computers and peripheral devices and are ideal for use with multimedia devices, such as digital video cameras.

Your computer provides a IEEE 1394 connector on both the front and back panels (see "Front and Back View of the Computer" on page 53 for locations.)

 **NOTE:** The connector can accept six-pin IEEE 1394 devices with the use of an adapter.

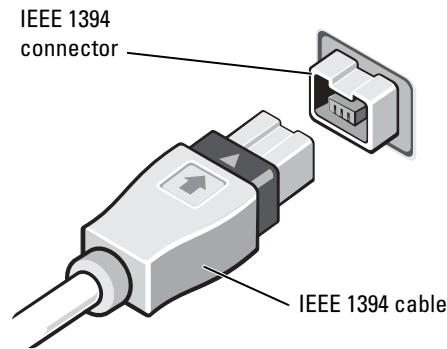

Setting Up a Home and Office Network

Connecting to a Network Adapter

Before you connect your computer to a network, the computer must have a network adapter installed and a network cable connected to it.

To connect a network cable:

- 1 Connect the network cable to the network adapter connector on the back of your computer.

 **NOTE:** Insert the cable until it clicks into place, and then gently pull it to ensure that it is secure.

- 2 Connect the other end of the network cable to a network connection device, such as a network wall jack.

 **NOTE:** Do not use a network cable with a telephone wall jack.

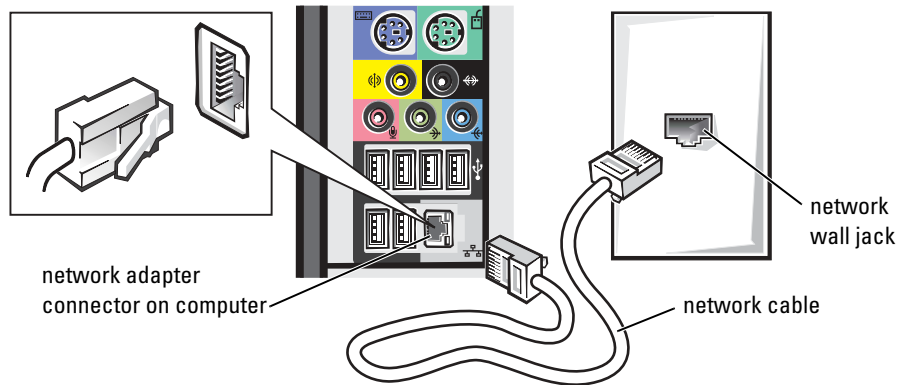

Network Setup Wizard

The Microsoft® Windows® XP operating system provides a Network Setup Wizard to guide you through the process of sharing files, printers, or an Internet connection between computers in a home or small office.

- 1 Click the **Start** button, point to **All Programs**→**Accessories**→**Communications**, and then click **Network Setup Wizard**.
- 2 On the welcome screen, click **Next**.
- 3 Click **Checklist for creating a network**.

 **NOTE:** Selecting the **This computer connects directly to the Internet** connection method enables the integrated firewall provided with Windows XP.

- 4 Complete the checklist and required preparations.
- 5 Return to the Network Setup Wizard and follow the instructions on the screen.

Connecting to the Internet

 **NOTE:** ISPs and ISP offerings vary by country.

To connect to the Internet, you need a modem or network connection and an Internet service provider (ISP), such as AOL or MSN. Your ISP will offer one or more of the following Internet connection options:

- Dial-up connections that provide Internet access through a phone line. Dial-up connections are considerably slower than DSL and cable modem connections.
- DSL connections that provide high-speed Internet access through your existing phone line. With a DSL connection, you can access the Internet and use your phone on the same line simultaneously.
- Cable modem connections that provide high-speed Internet access through your local cable TV line.

If you are using a dial-up connection, connect a telephone line to the modem connector on your computer and to the telephone wall jack before you set up your Internet connection. If you are using a DSL or cable modem connection, contact your ISP for setup instructions.

Setting Up Your Internet Connection

To set up an AOL or MSN connection:

- 1 Save and close any open files, and exit any open programs.
- 2 Double-click the **MSN Explorer** or **AOL** icon on the Windows® desktop.
- 3 Follow the instructions on the screen to complete the setup.

If you do not have an **MSN Explorer** or **AOL** icon on your desktop or if you want to set up an Internet connection with a different ISP:

- 1 Save and close any open files, and exit any open programs.
- 2 Click the **Start** button and click **Internet Explorer**.
The **New Connection Wizard** appears.
- 3 Click **Connect to the Internet**.
- 4 In the next window, click the appropriate option:
 - If you do not have an ISP and want to select one, click **Choose from a list of Internet service providers (ISPs)**.
 - If you have already obtained setup information from your ISP but you did not receive a setup CD, click **Set up my connection manually**.
 - If you have a CD, click **Use the CD I got from an ISP**.
- 5 Click **Next**.

If you selected **Set up my connection manually**, continue to step 6. Otherwise, follow the instructions on the screen to complete the setup.

 **NOTE:** If you do not know which type of connection to select, contact your ISP.

- 6 Click the appropriate option under **How do you want to connect to the Internet?**, and then click **Next**.
- 7 Use the setup information provided by your ISP to complete the setup.

If you are having problems connecting to the Internet, see "E-Mail, Modem, and Internet Problems" on page 27. If you cannot connect to the Internet but have successfully connected in the past, the ISP might have a service outage. Contact your ISP to check the service status, or try connecting again later.

Copying CDs and DVDs

 **NOTE:** Ensure that you follow all copyright laws when you create CDs.

This section applies only to computers that have a CD-R, CD-RW, DVD+RW, DVD+R, or DVD/CD-RW combo drive.

The following instructions show how to make an exact copy of a CD or DVD. You can also use Sonic RecordNow for other purposes, including creating CDs from audio files on your computer and creating MP3 CDs. For instructions, see the Sonic RecordNow documentation that came with your computer. Open Sonic RecordNow, click the question mark icon in the upper-right corner of the window, and click **RecordNow Help** or **RecordNow Tutorial**.

How to Copy a CD or DVD

 **NOTE:** If you have a DVD/CD-RW combo drive and you experience recording problems, check for available software patches at the Sonic support website at support.sonic.com.

 **NOTE:** Most commercial DVDs have copyright protection and cannot be copied using Sonic RecordNow.

- 1 Click the **Start** button, point to **All Programs**→ **Sonic**→ **RecordNow!**→ **RecordNow!**.
- 2 Click either the audio tab or the data tab, depending on the kind of CD you are planning to copy.
- 3 Click **Exact Copy**.
- 4 To copy the CD or DVD:
 - *If you have one CD or DVD drive*, ensure that the settings are correct and click **Copy**. The computer reads your source CD or DVD and copies it to a temporary folder on your computer hard drive.
When prompted, insert a blank CD or DVD into the CD or DVD drive and click **OK**.
 - *If you have two CD or DVD drives*, select the drive into which you have inserted your source CD or DVD and click **Copy**. The computer copies the data on the CD or DVD to the blank CD or DVD.

Once you have finished copying the source CD or DVD, the CD or DVD that you have created automatically ejects.

Using Blank CD-Rs and CD-RWs

Your CD-RW drive can write to two different types of recording media—CD-Rs and CD-RWs. Use blank CD-Rs to record music or permanently store data files. After creating a CD-R, you cannot write to that CD-R again without changing your method of recording (see the Sonic documentation for more information). Use blank CD-RWs to write to CDs or to erase, rewrite, or update data on CDs.

Helpful Tips

- Use Microsoft® Windows® Explorer to drag and drop files to a CD-R or CD-RW only after you start Sonic RecordNow and open a RecordNow project.
- You must use CD-Rs to burn music CDs that you want to play in regular stereos. CD-RWs do not play in most home or car stereos.
- You cannot create audio DVDs with Sonic RecordNow.
- Music MP3 files can be played only on MP3 players or on computers that have MP3 software installed.
- Do not burn a blank CD-R or CD-RW to its maximum capacity; for example, do not copy a 650-MB file to a 650-MB blank CD. The CD-RW drive needs 1 or 2 MB of the blank CD to finalize the recording.
- Use a blank CD-RW to practice CD recording until you are familiar with CD recording techniques. If you make a mistake, you can erase the data on the CD-RW and try again. You can also use blank CD-RWs to test music file projects before you record the project permanently to a blank CD-R.
- See the Sonic support website at support.sonic.com for additional information.

Hyper-Threading

Hyper-Threading is an Intel® technology that can enhance overall computer performance by allowing one physical microprocessor to function as two logical microprocessors, capable of performing certain tasks simultaneously. It is recommended that you use the Microsoft® Windows® XP operating system because Windows XP is optimized to take advantage of Hyper-Threading technology. While many programs can benefit from Hyper-Threading, some programs have not been optimized for Hyper-Threading and may require an update from the software manufacturer. Contact the software manufacturer for updates and information about using Hyper-Threading with your software.

To determine if your computer is using Hyper-Threading technology:

- 1 Click the **Start** button, right-click **My Computer**, and then click **Properties**.
- 2 Click **Hardware** and click **Device Manager**.
- 3 In the **Device Manager** window, click the plus (+) sign next to the processor type. If Hyper-Threading is enabled, the processor is listed twice.

You can enable or disable Hyper-Threading through the system setup program. For more information on accessing the system setup program, see page 78. For more information on Hyper-Threading, search the Knowledge Base on the Dell Support website at support.dell.com.

Booting to a USB Device

 **NOTE:** To boot to a USB device, the device must be bootable. To make sure your device is bootable, check the device documentation.

To restart your computer to a USB device such as a memory key or CD-RW drive:

- 1 Connect the USB device to a USB connector (see page 54).
- 2 Shut down (see page 21) and restart the computer.
- 3 Turn on the computer. When the DELL™ logo appears, press <F12> immediately. If you wait too long and the Microsoft® Windows® logo appears, continue to wait until you see the Windows desktop. Then shut down your computer through the **Start** menu and try again.

 **NOTE:** This changes the boot sequence for one time only. On the next start-up, the computer boots according to the devices specified in the system setup program.

- 4 When the boot device list appears, highlight **USB Flash Device** and press <Enter>. The computer restarts to the connected USB device.

Turning Off Your Computer

 **NOTICE:** To avoid losing data, turn off your computer by performing a Microsoft® Windows® operating system shutdown, as described next, rather than by pressing the power button.

 **NOTE:** As an alternative to turning off your computer, you can set your computer to enter standby or hibernate mode. For information on power conservation modes, see the *Tell Me How* help file, or search for the keyword *standby* or *hibernate* in the Windows XP Help and Support Center. To access help files, see page 25.

- 1 Save and close any open files, exit any open programs, click the **Start** button, and then click **Turn Off Computer**.
- 2 In the **Turn off computer** window, click **Turn off**.

The computer turns off after the shutdown process finishes.

Solving Problems

Finding Solutions

Sometimes it is difficult to figure out where to go for answers. Use this chart to help you quickly find the answers to your questions.

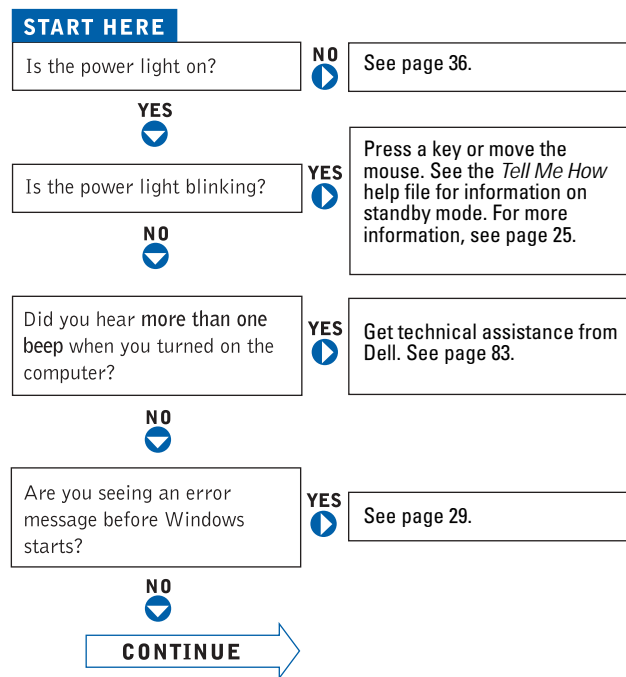

Are you having a problem with... NO	▶	video or the monitor?	YES ▶	See page 40.
		sound or the speakers?	YES ▶	See page 39.
		the printer?	YES ▶	See page 37.
		the modem?	YES ▶	See page 27.
		the mouse?	YES ▶	See page 34.
		the keyboard?	YES ▶	See page 33.
		the hard drive or a disk drive?	YES ▶	See page 26.
		the network adapter?	YES ▶	See page 35.
		the scanner?	YES ▶	See page 38.
		Windows error messages?	YES ▶	See page 29.
		a program?	YES ▶	See page 30.
		the Internet?	YES ▶	See page 27.
		your e-mail?	YES ▶	See page 27.
	Are you having some other type of problem?	YES ▶	See page 30.	

Finding Help Information

TO ACCESS THE TELL ME HOW HELP FILE —

- 1 Click the Start button and click **Help and Support**.
- 2 Click **User and system guides** and click **User's guides**.
- 3 Click **Tell Me How**.

TO ACCESS WINDOWS HELP —

- 1 Click the Start button and click **Help and Support**.
- 2 Type a word or phrase that describes your problem and click the arrow icon.
- 3 Click the topic that describes your problem.
- 4 Follow the instructions shown on the screen.

TO LOCATE ADDITIONAL INFORMATION FOR YOUR COMPUTER — See page 9.

Battery Problems



CAUTION: There is a danger of a new battery exploding if it is incorrectly installed. Replace the battery only with the same or equivalent type recommended by the manufacturer. Discard used batteries according to the manufacturer's instructions.



CAUTION: Before you begin any of the procedures in this section, follow the safety instructions in the *Product Information Guide*.

REPLACE THE BATTERY — If you have to repeatedly reset time and date information after turning on the computer, or if an incorrect time or date displays during start-up, replace the battery (see page 79). If the battery still does not work properly, contact Dell (see page 83).

Drive Problems

CD drive problems

 **NOTE:** High-speed CD drive vibration is normal and may cause noise, which does not indicate a defect in the drive or the CD.

ADJUST THE WINDOWS VOLUME CONTROL — Click the speaker icon in the lower-right corner of your screen.

- Ensure that the volume is turned up by clicking the slider and dragging it up.
- Ensure that the sound is not muted by clicking any boxes that are checked.

TEST THE DRIVE WITH ANOTHER CD — Insert another CD to eliminate the possibility that the original CD is defective.

CHECK THE SPEAKERS AND SUBWOOFER — See "Sound and Speaker Problems" on page 39.

ENSURE THAT WINDOWS RECOGNIZES THE DRIVE — Click the **Start** button and click **My Computer**. If the CD drive is not listed, perform a full scan with your antivirus software to check for and remove viruses. Viruses can sometimes prevent the Microsoft® Windows® operating system from recognizing the drive.

CLEAN THE DISC — See the *Tell Me How* help file for instructions on cleaning your CDs. To access help files, see page 25.

Problems writing to a CD-RW drive

CLOSE OTHER PROGRAMS — The CD-RW drive must receive a steady stream of data when writing. If the stream is interrupted, an error occurs. Try closing all programs before writing to the CD-RW.

TURN OFF STANDBY MODE IN WINDOWS BEFORE WRITING TO A CD-RW DISC — For information on power conservation modes, see the *Tell Me How* help file or search for the keyword *standby* in the Windows XP Help and Support Center. To access help files, see page 25.

DVD drive problems

 **NOTE:** Because of different regions worldwide and different disc formats, not all DVD titles work in all DVD drives.

TEST THE DRIVE WITH ANOTHER DVD — Insert another DVD to eliminate the possibility that the original DVD is defective.

ENSURE THAT WINDOWS RECOGNIZES THE DRIVE — Click the **Start** button and click **My Computer**. If the DVD drive is not listed, perform a full scan with your antivirus software to check for and remove viruses. Viruses can sometimes prevent Windows from recognizing the drive.

CLEAN THE DISC — See the *Tell Me How* help file for instructions on cleaning your DVDs. To access help files, see page 25.

CHECK FOR INTERRUPT REQUEST CONFLICTS — See page 52.

Hard drive problems

RUN CHECK DISK —

- 1 Click the **Start** button and click **My Computer**.
- 2 Right-click the drive letter (local disk) that you want to scan for errors, and then click **Properties**.
- 3 Click the **Tools** tab.
- 4 Under **Error-checking**, click **Check Now**.
- 5 Click **Start**.

E-Mail, Modem, and Internet Problems

 **NOTE:** Connect the modem to an analog telephone jack only. The modem does not operate while it is connected to a digital telephone network.

CHECK THE TELEPHONE LINE CONNECTION — Verify that the telephone line is connected to the jack on the modem. (The jack has either a green label or a connector-shaped icon next to it.) Ensure that you hear a click when you insert the telephone line connector into the modem.

CHECK THE TELEPHONE JACK — Disconnect the telephone line from the modem and connect it to a telephone. Listen for a dial tone.

CONNECT THE MODEM DIRECTLY TO THE TELEPHONE WALL JACK — If you have other telephone devices sharing the line, such as an answering machine, fax machine, surge protector, or line splitter, then bypass them and use the telephone to connect the modem directly to the telephone wall jack.

USE A DIFFERENT TELEPHONE LINE — If you are using a line that is 3 m (10 ft) or more in length, try a shorter one.

RUN THE MODEM HELPER DIAGNOSTICS — Click the **Start** button, point to **All Programs**, and then click **Modem Helper**. Follow the instructions on the screen to identify and resolve modem problems. (Modem Helper is not available on all computers.)

VERIFY THAT THE MODEM IS COMMUNICATING WITH WINDOWS® —

- 1 Click the **Start** button and click **Control Panel**.
- 2 Click **Printers and Other Hardware**.
- 3 Click **Phone and Modem Options**.
- 4 Click the **Modems** tab.
- 5 Click the COM port for your modem.
- 6 Click **Properties**, click the **Diagnostics** tab, and then click **Query Modem** to verify that the modem is communicating with Windows.
If all commands receive responses, the modem is operating properly.

TURN OFF CALL WAITING (CATCH-PHONE) — See your telephone directory for instructions on deactivating this feature. Then adjust the dial-up networking connection properties.

- 1 Click the **Start** button and click **Control Panel**.
- 2 Click **Printers and Other Hardware**, and then click **Phone and Modem Options**.
- 3 Click your connection type to highlight it.
- 4 Click the **Dialing Rules** tab and click **Edit**.
- 5 Click the **To Disable Call Waiting** box to place a checkmark in it.
- 6 Select the disable code from the drop-down menu (for example, *70).
- 7 Click **Apply** and click **OK**.

ENSURE THAT YOU ARE CONNECTED TO THE INTERNET — With the Outlook Express e-mail program open, click **File**. If **Work Offline** has a checkmark next to it, click the checkmark to remove it and connect to the Internet.

ENSURE THAT YOU HAVE SUBSCRIBED TO AN INTERNET SERVICE PROVIDER — Contact an Internet service provider to subscribe.

CONTACT YOUR INTERNET SERVICE PROVIDER — Contact your Internet service provider for assistance.

Error Messages

If the message is not listed, see the documentation for the operating system or the program that was running when the message appeared.

A FILENAME CANNOT CONTAIN ANY OF THE FOLLOWING CHARACTERS: \ / : * ? " < > | — Do not use these characters in filenames.

A REQUIRED .DLL FILE WAS NOT FOUND — The program that you are trying to open is missing an essential file. To remove and then reinstall the program:

- 1 Click the **Start** button and click **Control Panel**.
- 2 Click **Add or Remove Programs**.
- 3 Select the program you want to remove.
- 4 Click the **Change or Remove Program** icon.
- 5 See the program documentation for installation instructions.

INSERT BOOTABLE MEDIA — The operating system is trying to boot to a nonbootable CD. Insert a bootable CD.

NOT ENOUGH MEMORY OR RESOURCES. CLOSE SOME PROGRAMS AND TRY AGAIN — You have too many programs open. Close all windows and open the program that you want to use. In some cases, you might have to restart your computer to restore computer resources. If so, run the program that you want to use first.

OPERATING SYSTEM NOT FOUND — Contact Dell (see page 83).

THE FILE BEING COPIED IS TOO LARGE FOR THE DESTINATION DRIVE — The file that you are trying to copy is too large to fit on the disk. Try copying the file to a blank disk or using a larger-capacity disk.

x:\ IS NOT ACCESSIBLE. THE DEVICE IS NOT READY — Insert a disc into the drive and try again.

General Problems

The computer stops responding

TURN THE COMPUTER OFF — If your computer locks up and you are unable to get a response by pressing a key on your keyboard or moving your mouse, press and hold the power button for at least 8 to 10 seconds until the computer turns off. Then press the power button again to turn on the computer. You might lose data if you are unable to perform an operating system shutdown.

A program stops responding

END THE PROGRAM —

- 1 Press <Ctrl><Shift><Esc> simultaneously.
- 2 Click **Applications**.
- 3 Click the program that is no longer responding.
- 4 Click **End Task**.

A program crashes repeatedly

 **NOTE:** Software usually includes installation instructions in its documentation or on a CD.

CHECK THE SOFTWARE DOCUMENTATION — Many software manufacturers maintain websites with information that may help you solve the problem. Ensure that you properly installed and configured the program. If necessary, uninstall and then reinstall the program.

A program is designed for an earlier Microsoft® Windows® operating system

RUN THE PROGRAM COMPATIBILITY WIZARD —

Windows XP provides a Program Compatibility Wizard that configures a program so it runs in an environment similar to non-Windows XP operating system environments.

- 1 Click the **Start** button, point to **All Programs**→**Accessories**, and then click **Program Compatibility Wizard**.
- 2 In the welcome screen, click **Next**.
- 3 Follow the instructions on the screen.

A solid blue screen appears

TURN THE COMPUTER OFF — If the computer does not respond to a keystroke or a proper shutdown, press the power button for at least 8 to 10 seconds until the computer turns off. Press the power button again to restart the computer. The chkdsk program automatically runs during the start-up process. Follow the instructions on the screen.

Other software problems

CHECK THE SOFTWARE DOCUMENTATION OR CONTACT THE SOFTWARE MANUFACTURER FOR TROUBLESHOOTING INFORMATION

BACK UP YOUR FILES IMMEDIATELY — If your computer has a CD-RW drive or a zip drive installed, see the drive's documentation for instructions.

ENSURE THAT YOU HAVE NOT MADE AN ERROR WHILE ENTERING DATA — See the program documentation to ensure that the values or characters you are entering are valid.

CHECK FOR VIRUSES — Use a virus-scanning program to check the hard drive or CDs.

RESTART THE COMPUTER — Save and close any open files, exit any open programs, and then shut down your computer through the **Start** menu instead of by pressing the power button. Otherwise, you may lose data.

CHECK FOR COMPATIBILITY —

- Ensure that the program is compatible with the operating system installed on your computer and that your computer meets the minimum hardware requirements needed to run the software. See the software documentation for information.
- If necessary, uninstall and then reinstall the program.

ENSURE THAT YOU PROPERLY INSTALLED AND CONFIGURED THE PROGRAM — See the software documentation for information. If necessary, uninstall and then reinstall the program.

Other technical problems

GO TO THE DELL SUPPORT WEBSITE — Go to support.dell.com for help with general usage, installation, and troubleshooting questions. The support website offers several different tools to help you, such as Dell Forum—a chat room where you can communicate with other Dell customers about their computers and gain access to technical support through e-mail. See "Dell Support Website" on page 9 for more information about the website. See "Dell Technical Support Policy (U.S. Only)" on page 81 for a description of the hardware and software support provided by Dell.

CALL DELL — If you cannot solve your problem using the Dell Support website or e-mail service, call Dell for technical assistance (see page 83). See "Dell Technical Support Policy (U.S. Only)" on page 81 for a description of the hardware and software support provided by Dell.

General hardware problems

If your computer exhibits one or more of the following symptoms, a device conflict may exist:

- Your computer locks up, particularly while using a specific device.
- A recently added device does not work.
- A sound card emits noise or demonstrates other problems.
- Unintelligible characters print from the printer.
- The mouse pointer does not move or "stutters" when it moves.
- Messages appear stating that the computer is not operating at maximum performance.
- Errors occur and programs crash for no apparent reason.
- Nothing displays on the monitor.

REMOVE ANY RECENTLY ADDED HARDWARE TO SEE IF IT RESOLVES THE CONFLICT — If removing the hardware resolves the conflict, see the hardware documentation for configuration and troubleshooting instructions. If the problem persists, contact the hardware manufacturer for technical assistance.

CHECK YOUR OPERATING SYSTEM DOCUMENTATION FOR ADDITIONAL TROUBLESHOOTING INFORMATION

CHECK FOR INTERRUPT REQUEST CONFLICTS — See page 52.

IEEE 1394 Device Problems

 **NOTE:** Check Windows Explorer to see if your device is listed as a drive.

CHECK THE IEEE 1394 DEVICE — Ensure that the IEEE 1394 device is properly inserted into the connector.

ENSURE THAT THE IEEE 1394 DEVICE IS RECOGNIZED BY WINDOWS® —

1 Click the Start button and click Control Panel.

2 Click Printers and Other Hardware.

If your IEEE 1394 device is listed, Windows recognizes the device.

IF YOU HAVE PROBLEMS WITH A DELL-PROVIDED IEEE 1394 DEVICE — Contact Dell (see page 83).

IF YOU HAVE PROBLEMS WITH AN IEEE 1394 DEVICE NOT PROVIDED BY DELL — Contact the IEEE 1394 device manufacturer.

Keyboard Problems

RESTART THE COMPUTER —

- If the mouse is functioning, shut down the computer through the **Start** menu (see page 21). After the computer shuts down, press the power button to restart the computer.
- If the computer does not respond to a keystroke or the mouse, press the power button for at least 8 to 10 seconds until the computer turns off. Press the power button again to restart the computer.

CHECK THE KEYBOARD CABLE —

- Ensure that the keyboard cable is firmly connected to the computer.
- Shut down the computer (see page 21), reconnect the keyboard cable as shown on the setup diagram for your computer, and then restart the computer.
- Check the cable connector for bent or broken pins and for damaged or frayed cables. Straighten bent pins.
- Remove keyboard extension cables and connect the keyboard directly to the computer.

TEST THE KEYBOARD — Connect a properly working keyboard to the computer, and try using the keyboard. If the new keyboard works, the original keyboard is faulty.

CHECK FOR INTERRUPT REQUEST CONFLICTS — See page 52.

Mouse Problems

RESTART THE COMPUTER —

- 1 Simultaneously press <Ctrl><Esc> to display the **Start** menu.
- 2 Type u, press the keyboard arrow keys to highlight **Shut down** or **Turn Off**, and then press <Enter>.
- 3 After the computer turns off, press the power button to restart the computer.

IF YOU CONNECTED THE MOUSE BEFORE TURNING ON THE COMPUTER, RECONNECT THE MOUSE CABLE —

- 1 Simultaneously press <Ctrl><Esc> to display the **Start** menu.
- 2 Type u, press the keyboard arrow keys to highlight **Shut down** or **Turn Off**, and then press <Enter>.
- 3 After the computer turns off, reconnect the mouse cable as shown on the setup diagram for your computer.
- 4 Start the computer.

IF YOU CONNECTED THE MOUSE AFTER TURNING ON THE COMPUTER, REMOVE THE POWER CABLE, AND THEN RECONNECT THE MOUSE CABLE — If the mouse is connected after the power is turned on, the mouse appears to be nonfunctional. To make the mouse function properly:

- 1 While your computer is on, remove the power cable from the back of the computer.
- 2 Connect the mouse to the computer.
- 3 Reconnect the power cable.
- 4 Turn on your computer.

Pressing the power button does not clear the computer's settings and does not restore mouse functionality.

CHECK THE MOUSE CABLE —

- Check the cable connector for bent or broken pins and for damaged or frayed cables. Straighten bent pins.
- Ensure that the cable is firmly connected to the computer.

TEST THE MOUSE — Connect a properly working mouse to the computer, and try using the mouse. If the new mouse works, the original mouse was faulty.

CHECK THE MOUSE SETTINGS —

- 1 Click the **Start** button, click **Control Panel**, and then click **Printers and Other Hardware**.
- 2 Click **Mouse**.
- 3 Try adjusting the settings.

REINSTALL THE MOUSE DRIVER — See page 49.

CHECK FOR INTERRUPT REQUEST CONFLICTS — See page 52.

Network Problems

CHECK THE NETWORK CABLE CONNECTOR — Ensure that the network cable is connected as shown on page 16.

CHECK THE NETWORK LIGHTS ON THE BACK OF THE COMPUTER — No light indicates that no network communication exists. Replace the network cable.

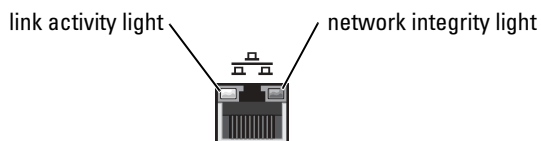

RESTART THE COMPUTER AND TRY TO LOG ON TO THE NETWORK AGAIN

CHECK YOUR NETWORK SETTINGS — Contact your network administrator or the person who set up your network to verify that your network settings are correct and that the network is functioning.

CHECK FOR INTERRUPT REQUEST CONFLICTS — See page 52.

PC Card Problems

 **NOTE:** Your computer is designed for 16-bit PCMCIA cards only. Do not use a 32-bit CardBus.

CHECK THE PC CARD — Ensure that the PC Card is properly inserted into the connector.

ENSURE THAT THE CARD IS RECOGNIZED BY WINDOWS® — Double-click the **Safely Remove Hardware** icon in the Windows taskbar. Ensure that the card is listed.

IF YOU HAVE PROBLEMS WITH A DELL-PROVIDED PC CARD — Contact Dell (see page 83).

IF YOU HAVE PROBLEMS WITH A PC CARD NOT PROVIDED BY DELL — Contact the PC card manufacturer.

Power Problems



CAUTION: Before you begin any of the procedures in this section, follow the safety instructions in the *Product Information Guide*.

ADJUST THE POWER PROPERTIES — Your computer may be in standby or hibernate mode. For information on power conservation modes, see the *Tell Me How* help file, or search for the keyword *standby* or *hibernate* in the Windows XP Help and Support Center. To access help files, see page 25.

IF THE POWER LIGHT IS GREEN AND THE COMPUTER IS NOT RESPONDING — See "Diagnostic Lights" on page 43.

IF THE POWER LIGHT IS BLINKING GREEN — The computer is in standby mode. Press a key on the keyboard or move the mouse to resume normal operation.

IF THE POWER LIGHT IS OFF — The computer is either turned off or is not receiving power.

- Reseat the power cable into both the power connector on the back of the computer and the electrical outlet.
- If the computer is plugged into a power strip, ensure that the power strip is plugged into an electrical outlet and that the power strip is turned on.
- Ensure that the electrical outlet is working by testing it with another device, such as a lamp.
- Bypass power protection devices, power strips, and power extension cables to verify that the computer turns on.
- Ensure that the main power cable is securely connected to the system board (see page 61).
- Ensure that the front panel cable is securely connected to the system board (see page 61).
- If the problem persists, contact Dell (see page 83).

IF THE POWER LIGHT IS STEADY AMBER — The computer is receiving electrical power, but an internal power problem might exist.

- Ensure that the microprocessor power cable is securely connected to the system board (see page 61).
- Remove and then reinstall the memory modules (see page 68).
- Remove and then reinstall any cards (see page 62).
- If the problem persists, contact Dell (see page 83).

IF THE POWER LIGHT IS BLINKING AMBER — A device might be malfunctioning or incorrectly installed.

- Ensure that the main power cable is securely connected to the system board (see page 61).
- Remove and then reinstall the video card, if applicable (see page 66).
- If the problem persists, contact Dell (see page 83).

ELIMINATE INTERFERENCE — Electrical appliances on the same circuit or operating near the computer can cause interference. Other causes of interference are:

- Power extension cables
- Keyboard and mouse extension cables
- Too many devices on a power strip
- Multiple power strips connected to the same electrical outlet

Printer Problems



NOTE: Dell does not cover the printer's warranty. If you need technical assistance for your printer, call the printer's manufacturer. See the printer documentation for the correct phone number.

CHECK THE PRINTER DOCUMENTATION — See the printer documentation for setup and troubleshooting information.

ENSURE THAT THE PRINTER IS TURNED ON — See the printer documentation for power button information.

VERIFY THE PRINTER CABLE CONNECTIONS —

- See the printer documentation for cable connection information.
- Ensure that the printer cables are securely connected to the printer and the computer (see page 13).

TEST THE ELECTRICAL OUTLET — Ensure that the electrical outlet is working by testing it with another device, such as a lamp.

VERIFY THAT THE PRINTER IS RECOGNIZED BY WINDOWS® —

- 1 Click the **Start** button and click **Control Panel**.
- 2 Click **Printers and Other Hardware**.
- 3 Click **View installed printers or fax printers**.
If the printer is listed, right-click the printer icon.
- 4 Click **Properties**, and then select the **Ports** tab. For a parallel printer, ensure that the **Print to the following port(s)**: setting is **LPT1 (Printer Port)**. For a USB printer, ensure that the **Print to the following port(s)**: setting is **USB**.

REINSTALL THE PRINTER DRIVER — See the printer documentation for instructions.

Scanner Problems

 **NOTE:** Dell does not cover the scanner's warranty. If you need technical assistance for your scanner, call the scanner's manufacturer. See the scanner documentation for the correct phone number.

CHECK THE SCANNER DOCUMENTATION — See the scanner documentation for setup and troubleshooting information.

UNLOCK THE SCANNER — Ensure that your scanner is unlocked if it has a locking tab or button.

RESTART THE COMPUTER AND TRY THE SCANNER AGAIN

CHECK THE CABLE CONNECTIONS —

- If your scanner has a power cable, ensure that the power cable is firmly connected to a working electrical outlet and that the scanner is turned on.
- Ensure that the scanner cable is firmly connected to the computer and to the scanner.

VERIFY THAT THE SCANNER IS RECOGNIZED BY MICROSOFT® WINDOWS® —

- 1 Click the **Start** button and click **Control Panel**.
- 2 Click **Printers and Other Hardware**.
- 3 Click **Scanners and Cameras**.
If your scanner is listed, Windows recognizes the scanner.

REINSTALL THE SCANNER DRIVER — See the scanner documentation for instructions.

Sound and Speaker Problems

No sound from speakers

 **NOTE:** The volume control in some MP3 players overrides the Windows® volume setting. If you have been listening to MP3 songs, ensure that you did not turn the player volume down or off.

CHECK THE SPEAKER CABLE CONNECTIONS — Ensure that the speakers are connected as shown on the setup diagram supplied with the speakers. If you purchased a sound card, ensure that the speakers are connected to the card.

ENSURE THAT THE SUBWOOFER AND THE SPEAKERS ARE TURNED ON — See the setup diagram supplied with the speakers. If your speakers have volume controls, adjust the volume, bass, or treble to eliminate distortion.

ADJUST THE WINDOWS VOLUME CONTROL — Click or double-click the speaker icon in the lower-right corner of your screen. Ensure that the volume is turned up and that the sound is not muted.

DISCONNECT HEADPHONES FROM THE HEADPHONE CONNECTOR — Sound from the speakers is automatically disabled when headphones are connected to the computer's front-panel headphone connector.

TEST THE ELECTRICAL OUTLET — Ensure that the electrical outlet is working by testing it with another device, such as a lamp.

ENABLE DIGITAL MODE — Your speakers do not work if the CD drive is operating in analog mode. To enable digital mode:

- 1 Click the **Start** button, click **Control Panel**, and then click **Sounds, Speech, and Audio Devices**.
- 2 Click **Sounds and Audio Devices**.
- 3 Click the **Hardware** tab.
- 4 Double-click the name of your CD drive.
- 5 Click the **Properties** tab.
- 6 Check the **Enable digital CD audio for this CD-ROM device** box.

ELIMINATE POSSIBLE INTERFERENCE — Turn off nearby fans, fluorescent lights, or halogen lamps to check for interference.

RUN THE SPEAKER DIAGNOSTICS — Some speaker systems have self-diagnostics. See the speaker documentation for diagnostics instructions.

REINSTALL THE AUDIO (SOUND) DRIVER — See page 49.

CHECK FOR INTERRUPT REQUEST CONFLICTS — See page 52.

No sound from headphones

CHECK THE HEADPHONE CABLE CONNECTION — Ensure that the headphone cable is securely inserted into the headphone connector (see page 53).

DISABLE DIGITAL MODE — Your headphones do not work if the CD drive is operating in digital mode. To disable digital mode:

- 1 Click the **Start** button, click **Control Panel**, and then click **Sounds, Speech, and Audio Devices**.
- 2 Click **Sounds and Audio Devices**.
- 3 Click the **Hardware** tab.
- 4 Double-click the name of your CD drive.
- 5 Click the **Properties** tab.
- 6 Uncheck the **Enable digital CD audio for this CD-ROM device box**.

ADJUST THE WINDOWS VOLUME CONTROL — Click or double-click the speaker icon in the lower-right corner of your screen. Ensure that the volume is turned up and that the sound is not muted.

Video and Monitor Problems

If the screen is blank

 **NOTE:** See the monitor documentation for troubleshooting procedures.

CHECK THE MONITOR POWER LIGHT — If the power light is off, firmly press the button to ensure that the monitor is turned on. If the power light is lit or blinking, the monitor has power. If the power light is blinking, press a key on the keyboard or move the mouse.

CHECK THE MONITOR CABLE CONNECTION — Check the connector for bent or broken pins. (It is normal for monitor cable connectors to have missing pins.) Ensure that the video cable is connected as shown on the setup diagram for your computer.

TEST THE ELECTRICAL OUTLET — Ensure that the electrical outlet is working by testing it with another device, such as a lamp.

SWAP THE POWER CABLES — Swap the computer and monitor power cables to determine if the power cable is defective.

TEST THE VIDEO EXTENSION CABLE (IF USED) — If you are using a video extension cable and removing the cable solves the problem, the cable is defective.

TEST ANOTHER MONITOR — If another monitor is available, connect it to the computer.

CHECK THE DIAGNOSTIC LIGHTS — See page 43.

If the screen is difficult to read

CHECK THE MONITOR SETTINGS — See the monitor documentation for instructions on adjusting the contrast and brightness, demagnetizing (degaussing) the monitor, and running the monitor self-test.

MOVE THE SUBWOOFER AWAY FROM THE MONITOR — If your speaker system includes a subwoofer, ensure that the subwoofer is at least 60 cm (2 ft) away from the monitor.

MOVE THE MONITOR AWAY FROM EXTERNAL POWER SOURCES — Fans, fluorescent lights, halogen lamps, and other electrical devices can cause the screen image to appear "shaky." Turn off nearby devices to check for interference.

ROTATE THE MONITOR TO FACE A DIFFERENT DIRECTION — Eliminate sunlight glare, which can cause poor picture quality.

ADJUST THE WINDOWS® DISPLAY SETTINGS —

- 1 Click the Start button and click Control Panel.
- 2 Click Appearance and Themes.
- 3 Click Display and click the Settings tab.
- 4 Try different settings for Screen resolution and Color quality.

RESTORE THE RECOMMENDED SETTINGS — Restore the original resolution and refresh rate settings. See the *Tell Me How* help file for instructions. To access help files, see page 25.

Advanced Troubleshooting

Diagnostic Lights

To help you troubleshoot a problem, your computer is equipped with four lights on the back panel labeled "A," "B," "C," and "D" (see page 57). These lights can be yellow or green. When the computer starts normally, the lights flash. After the computer starts, the lights remain green. If the computer malfunctions, the color and sequence of the lights identify the problem.







CAUTION: Before you begin any of the procedures in this section, follow the safety instructions in the *Product Information Guide*.



Light Pattern	Problem Description	Suggested Resolution
 A B C D	The computer is in a normal off condition or a possible pre-BIOS failure has occurred.	Verify that the computer is plugged into a working electrical outlet and that you have pressed the power button.





 = yellow



 = green

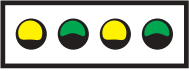

 = off

Light Pattern	Problem Description	Suggested Resolution
 <p>A B C D</p>	<p>Memory modules are detected, but a memory failure has occurred.</p>	<ul style="list-style-type: none"> • If you have one memory module installed, reinstall it (see page 68) and restart the computer. • If you have two or more memory modules installed, remove the modules, reinstall one module (see page 68), and then restart the computer. If the computer starts normally, reinstall an additional module. Continue until you have identified a faulty module or reinstalled all modules without error. • If available, install properly working memory of the same type into your computer (see page 68). • If the problem persists, contact Dell (see page 83).
 <p>A B C D</p>  <p>A B C D</p>	<p>A possible expansion card failure has occurred.</p>	<ol style="list-style-type: none"> 1 Determine if a conflict exists by removing a card (not the video card) (see page 65) and then restarting the computer. 2 If the problem persists, reinstall the card that you removed, remove a different card, and then restart the computer. 3 Repeat this process for each card. If the computer starts normally, troubleshoot the last card removed from the computer for resource conflicts (see "Resolving Software and Hardware Incompatibilities" on page 52). 4 If the problem persists, contact Dell (see page 83).

-  = yellow
-  = green
-  = off

Light Pattern	Problem Description	Suggested Resolution
 <p>A B C D</p>	A possible video card failure has occurred.	<ul style="list-style-type: none"> • If the computer has a video card, remove the card and reinstall it (see page 66), and restart the computer. • If the problem still exists, install a video card that you know works and restart the computer. • If the problem persists or the computer has integrated video, contact Dell (see page 83).
 <p>A B C D</p>	A possible floppy or hard drive failure has occurred.	Reseat all power and data cables and restart the computer.
 <p>A B C D</p>	A possible USB failure has occurred.	Reinstall all USB devices, check cable connections, and then restart the computer.
 <p>A B C D</p>	No memory modules are detected.	<ul style="list-style-type: none"> • Reinstall all memory modules (see page 68) and restart the computer. • To eliminate the possibility of a faulty memory connector, remove all memory modules (see page 68), reinstall one memory module (if the computer supports a single module), and then restart the computer. If the computer starts normally, move the memory module to a different connector and restart the computer. Continue until you have identified a faulty connector or reinstalled all modules without error.

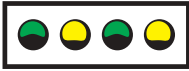
-  = yellow
-  = green
-  = off

Light Pattern	Problem Description	Suggested Resolution
 A B C D	Memory modules are detected, but a memory configuration or compatibility error exists.	<ul style="list-style-type: none"> • Ensure that there are no special memory module/memory connector placement requirements (see page 68). • Verify that the memory modules that you are installing are compatible with your computer (see page 68). • If the problem persists, contact Dell (see page 83).
 A B C D	Other failure has occurred.	<ul style="list-style-type: none"> • Ensure that the cables are properly connected from the hard drive, CD drive, and DVD drive to the system board (see page 61). • If the problem persists, contact Dell (see page 83).
 A B C D	The computer is in a normal operating condition after POST.	None.

 = yellow

 = green

 = off

Dell Diagnostics

If you experience a problem with your computer, perform the checks in "Solving Problems" on page 23 and run the Dell Diagnostics before you contact Dell for technical assistance. Running the Dell Diagnostics may help you resolve the problem without contacting Dell. If you do contact Dell, the test results can provide important information for Dell's service and support personnel.

The Dell Diagnostics allows you to:

- Perform express, extended, or custom tests on one or all devices
- Select tests based on a symptom of the problem you are having
- Choose how many times a test is run
- Display test results
- Suspend testing if an error is detected
- Access online help information that describes the tests and devices

- Receive status messages that tell you whether tests completed successfully
- Receive error messages if problems are detected

Starting the Dell Diagnostics



NOTICE: Only use the Dell Diagnostics to test your Dell™ computer. Using this program with other computers can result in error messages.

- 1 Shut down and restart the computer.
- 2 When the DELL™ logo appears, press <F12> immediately.
If you wait too long and the Microsoft® Windows® logo appears, continue to wait until you see the Windows desktop. Then shut down your computer through the **Start** menu and try again.
- 3 When the boot device list appears, highlight **Boot to Utility Partition** and press <Enter>.
- 4 When the Dell Diagnostics Main Menu appears, select the test you want to run (see page 47).

Dell Diagnostics Main Menu

- 1 After the Dell Diagnostics loads and the **Main Menu** screen appears, click the button for the option you want.



NOTE: The Service Tag number for your computer is located at the top of each test screen.

Option	Function
Express Test	Performs a quick test of devices. This test typically takes 10 to 20 minutes and requires no interaction on your part. Run Express Test first to increase the possibility of tracing the problem quickly.
Extended Test	Performs a thorough check of devices. This test typically takes an hour or more and requires you to answer questions periodically.
Custom Test	Tests a specific device. You can customize the tests you want to run.
Symptom Tree	Lists the most common symptoms encountered and allows you to select a test based on the symptom of the problem you are having.

- 2 If a problem is encountered during a test, a message displaying the error code and a description of the problem appear. Write down the error code and problem description and follow the instructions on the screen.

If you cannot resolve the error condition, contact Dell (see page 83).

- 3 If you run a test from the **Custom Test** or **Symptom Tree** option, click the applicable tab described in the following table for more information.

Tab	Function
Results	Displays the results of the test and any error conditions encountered.
Errors	Displays error conditions encountered, error codes, and problem description.
Help	Describes the test and may indicate requirements for running the test.
Configuration	Displays your hardware configuration for the selected device. The Dell Diagnostics obtains your configuration information for all devices from the system setup program, memory, and various internal tests and displays it in the device list in the left pane of the screen. The device list may not display the names of all the components installed on your computer or all devices attached to your computer.
Parameters	Allows you to customize the test by changing the test settings.

- 4 Close the test screen to return to the **Main Menu** screen. To exit the Dell Diagnostics and restart the computer, close the **Main Menu** screen.

Drivers

What Is a Driver?

A driver is a program that controls a device such as a printer, mouse, or keyboard. All devices require a driver program.

A driver acts like a translator between the device and the programs that use the device. Each device has its own set of specialized commands that only its driver recognizes.

Many drivers, such as the keyboard driver, come with your Microsoft® Windows® operating system. You may need to install drivers if you:

- Upgrade your operating system.
- Reinstall your operating system.
- Connect or install a new device.

If you experience a problem with any device, perform the steps in the following sections to identify whether the driver is the source of your problem and if necessary, to update the driver.

Identifying Drivers

- 1 Click the **Start** button and click **Control Panel**.
- 2 In the **Control Panel** window, under **Pick a Category**, click **Performance and Maintenance**.
- 3 In the **Performance and Maintenance** window, click **System**.
- 4 In the **System Properties** window, click the **Hardware** tab.

- 5 Click **Device Manager**.
- 6 In the **Device Manager** window, scroll down the list to see if any device has an exclamation point (a yellow circle with a [!]) on the device icon.
If an exclamation point is next to the device name, you may need to reinstall the driver or install a new driver.

Reinstalling Drivers

 **NOTICE:** The Dell Support website provides approved drivers for Dell™ computers. If you install drivers obtained from other sources, your computer might not work correctly.

Using Windows XP Device Driver Rollback

If a problem occurs on your computer after you install or update a driver, use Windows XP Device Driver Rollback to replace the driver with the previously installed version.

To use Device Driver Rollback:

- 1 Click the **Start** button and click **Control Panel**.
- 2 In the **Control Panel** window, under **Pick a Category**, click **Performance and Maintenance**.
- 3 In the **Performance and Maintenance** window, click **System**.
- 4 In the **System Properties** window, click the **Hardware** tab.
- 5 Click **Device Manager**.
- 6 In the **Device Manager** window, right-click the device for which the new driver was installed and click **Properties**.
- 7 Click the **Drivers** tab.
- 8 Click **Roll Back Driver**.

If Device Driver Rollback does not resolve the problem, then use System Restore (see page 49) to return your computer to the operating state that existed before you installed the new driver.

Restoring Your Operating System

You can restore your operating system in the following ways:

- Microsoft Windows XP System Restore returns your computer to an earlier operating state without affecting data files.
- Dell PC Restore by Symantec restores your hard drive to the operating state it was in when you purchased the computer. Dell PC Restore permanently deletes all data on the hard drive and removes any applications installed after you received the computer.

Using Microsoft Windows XP System Restore

The Microsoft Windows XP operating system provides System Restore to allow you to return your computer to an earlier operating state (without affecting data files) if changes to the hardware, software, or other system settings have left the computer in an undesirable operating state. See the Windows Help and Support Center for information on using System Restore. To access help, see page 10.



NOTICE: Make regular backups of your data files. System Restore does not monitor your data files or recover them.



NOTE: The procedures in this document were written for the Windows default view, so they may not work if you set your Dell™ computer to the Windows Classic view.

Creating a Restore Point

- 1 Click the **Start** button and click **Help and Support**.
- 2 Click **System Restore**.
- 3 Follow the instructions on the screen.

Restoring the Computer to an Earlier Operating State

If problems occur after you install a device driver, use Device Driver Rollback (see page 50) to resolve the problem. If that is unsuccessful, then use System Restore.



NOTICE: Before you restore the computer to an earlier operating state, save and close any open files and exit any open programs. Do not alter, open, or delete any files or programs until the system restoration is complete.

- 1 Click the **Start** button, point to **All Programs**→**Accessories**→**System Tools**, and then click **System Restore**.
- 2 Ensure that **Restore my computer to an earlier time** is selected and click **Next**.
- 3 Click a calendar date to which you want to restore your computer.

The **Select a Restore Point** screen provides a calendar that allows you to see and select restore points. All calendar dates with available restore points appear in boldface type.

- 4 Select a restore point and click **Next**.
If a calendar date has only one restore point, then that restore point is automatically selected. If two or more restore points are available, click the restore point that you prefer.
- 5 Click **Next**.

The **Restoration Complete** screen appears after System Restore finishes collecting data and then the computer restarts.

- 6 After the computer restarts, click **OK**.

To change the restore point, you can either repeat the steps using a different restore point, or you can undo the restoration.

Undoing the Last System Restore

 **NOTICE:** Before you undo the last system restore, save and close all open files and exit any open programs. Do not alter, open, or delete any files or programs until the system restoration is complete.

- 1 Click the **Start** button, point to **All Programs**→**Accessories**→**System Tools**, and then click **System Restore**.
- 2 Click **Undo my last restoration** and click **Next**.

Using Dell PC Restore by Symantec

Use Dell PC Restore by Symantec only as the last method to restore your operating system. PC Restore restores your hard drive to the operating state it was in when you purchased the computer. Any programs or files added since you received your computer—including data files—are permanently deleted from the hard drive. Data files include documents, spreadsheets, e-mail messages, digital photos, music files, and so on. If possible, back up all data before using PC Restore.

 **NOTICE:** Using PC Restore permanently deletes all data on the hard drive and removes any applications or drivers installed after you received your computer. If possible, back up the data before using PC Restore.

To use PC Restore:

- 1 Turn on the computer.
During the boot process, a blue bar with **www.dell.com** appears at the top of the screen.
- 2 Immediately upon seeing the blue bar, press <Ctrl><F11>.
If you do not press <Ctrl><F11> in time, let the computer finish restarting, and then restart the computer again.

 **NOTICE:** If you do not want to proceed with PC Restore, click **Reboot** in the following step.

- 3 On the next screen that appears, click **Restore**.
- 4 On the next screen, click **Confirm**.
The restore process takes approximately 6–10 minutes to complete.
- 5 When prompted, click **Finish** to reboot the computer.

 **NOTE:** Do not manually shut down the computer. Click **Finish** and let the computer completely reboot.

- 6 When prompted, click **Yes**.
The computer restarts. Because the computer is restored to its original operating state, the screens that appear, such as the End User License Agreement, are the same ones that appeared the first time the computer was turned on.
- 7 Click **Next**.
The **System Restore** screen appears and the computer restarts.
- 8 After the computer restarts, click **OK**.

Enabling System Restore

If you reinstall Windows XP with less than 200 MB of free hard-disk space available, System Restore is automatically disabled. To see if System Restore is enabled:

- 1 Click the **Start** button and click **Control Panel**.
- 2 Click **Performance and Maintenance**.
- 3 Click **System**.
- 4 Click the **System Restore** tab.
- 5 Ensure that **Turn off System Restore** is unchecked.

Resolving Software and Hardware Incompatibilities

Windows XP IRQ conflicts occur if a device either is not detected during the operating system setup or is detected but incorrectly configured.

To check for conflicts on a computer running Windows XP:

- 1 Click the **Start** button and click **Control Panel**.
- 2 Click **Performance and Maintenance** and click **System**.
- 3 Click the **Hardware** tab and click **Device Manager**.
- 4 In the **Device Manager** list, check for conflicts with the other devices.
Conflicts are indicated by a yellow exclamation point (!) beside the conflicting device or a red x if the device has been disabled.
- 5 Double-click any conflict to display the **Properties** window.
If an IRQ conflict exists, the **Device** status area in the **Properties** window reports the cards or devices that share the device's IRQ.
- 6 Resolve conflicts by reconfiguring the devices or removing the devices from the **Device Manager**.

To use the Windows XP Hardware Troubleshooter:

- 1 Click the **Start** button and click **Help and Support**.
- 2 Type `hardware troubleshooter` in the **Search** field and click the arrow to start the search.
- 3 Click **Hardware Troubleshooter** in the **Search Results** list.
- 4 In the **Hardware Troubleshooter** list, click **I need to resolve a hardware conflict on my computer**, and click **Next**.

Adding Parts

Front and Back View of the Computer

Front View

 **NOTE:** The front-panel door does not close when you are using certain PC Cards or IEEE 1394, USB, or headphone connectors.

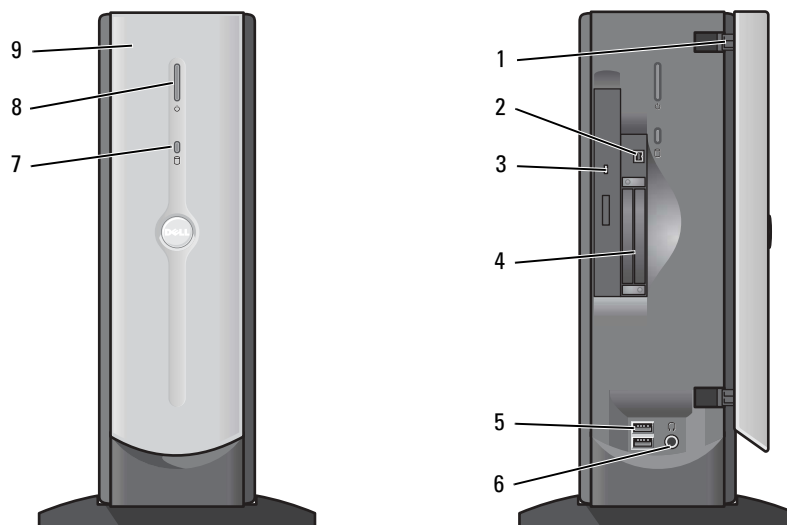



1	breakaway hinges (2)	To prevent damage to your computer, the front door is designed to "break away" if it is opened too far. To reattach the front door, see page 57.
2	IEEE 1394 connector	Attach high-speed serial multimedia devices, such as digital video cameras. (This feature is only available on computers with an optional IEEE 1394 connector.)
3	CD or DVD drive-activity light	The drive activity light is on when the computer reads data from the CD or DVD drive.
4	PC Card connectors (2)	Connect a PC Card into any of the PC Card connectors (available on computers with a PC Card option). Use the PC Card connectors for 16-bit PCMCIA cards only. Do not use a 32-bit CardBus.
5	USB 2.0 connectors (2)	Use the front USB connectors for devices that you connect occasionally, such as joysticks or cameras. It is recommended that you use the back USB connectors for devices that typically remain connected, such as printers and keyboards. NOTICE: This computer supports the use of a USB hub. However, do not connect two or more USB hubs to a USB connector. Doing so may cause the computer to unexpectedly restart. NOTE: If you attach a USB device that was not included in your original computer order, you may need to install a specific driver to make the device work. Check the documentation that came with the device or contact the USB device manufacturer for more information.
6	headphone connector	Use the headphone connector to attach headphones and most kinds of speakers.
7	hard-drive activity light	The hard-drive activity light is on when the computer reads data from or writes data to the hard drive. The light might also be on when devices such as your CD player are operating.
8	power button	Press to turn on the computer. NOTICE: To avoid losing data, do not use the power button to turn off the computer. Instead, perform an operating system shutdown.
9	front-panel door	Open the door to use the front-panel connectors. NOTE: The front door is removable; if you remove it or accidentally knock it off its hinges, it snaps back in place. For instructions on how to reattach the door, see page 57.

Back View

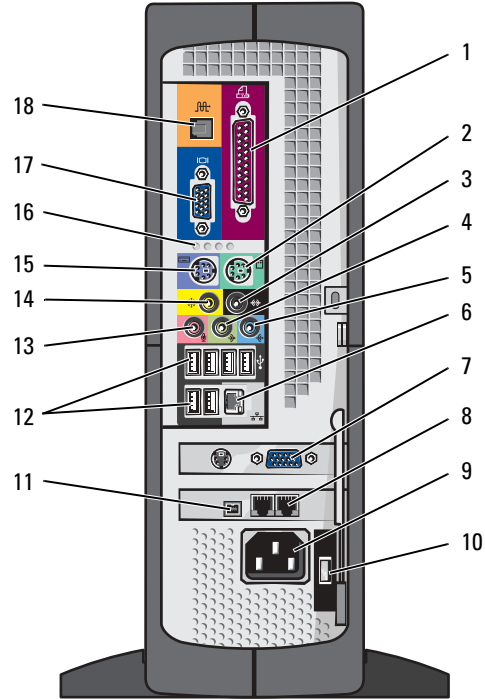
 **NOTE:** The front-panel door is removable; if you remove it or accidentally knock it off its hinges, it snaps back in place. For instructions on how to reattach the door, see page 57.





1	parallel connector	Connect a parallel device, such as a printer, to the parallel connector. If you have a USB printer, plug it into a USB connector.
2	mouse connector	Plug a standard mouse into the green mouse connector. Turn off the computer and any attached devices before you connect a mouse to the computer. If you have a USB mouse, plug it into a USB connector.
3	surround connector	Use the black surround connector to attach multichannel-capable speakers. (On computers with a sound card, use the connector on the card.)
4	line-out connector	Use the green line-out connector to attach headphones and most speakers with integrated amplifiers. (On computers with a sound card, use the connector on the card.)
5	line-in connector	Use the blue line-in connector to attach a record/playback device such as a cassette player, CD player, or VCR. (On computers with a sound card, use the connector on the card.)
6	network adapter connector	To attach your computer to a network or modem, connect one end of a network cable to either a network jack or your network device. Connect the other end of the network cable to the network adapter connector on the back panel of your computer. A click indicates that the network cable has been securely attached. On computers with a network connector card, use the connector on the card. It is recommended that you use Category 5 wiring and connectors for your network. If you must use Category 3 wiring, force the network speed to 10 Mbps to ensure reliable operation.
		 
		network jack modem jack
7	optional video card connector	Plug the cable from your monitor into the video card connector. (This feature is only available on computers with an optional video card.)
8	modem connectors (2)	Use the modem connector to connect your computer to the Internet.
9	power connector	Insert the power cable.
10	voltage selection switch (may not be available on all computers)	Your computer is equipped with either an auto-sensing voltage selector or a manual voltage selection switch. See the safety instructions information in your <i>Product Information Guide</i> for more information.
11	IEEE 1394 connector	Attach high-speed serial multimedia devices, such as digital video cameras. (This feature is only available on computers with an optional IEEE 1394 connector.)

12	USB 2.0 connectors (6)	Use the back USB connectors for devices that typically remain connected, such as printers and keyboards. It is recommended that you use the front USB connectors for devices that you connect occasionally, such as joysticks or cameras.
13	microphone connector	Use the pink microphone connector to attach a personal computer microphone for voice or musical input into a sound or telephony program.
14	center/LFE connector	Use the yellow center/LFE connector (available on computers with integrated sound) to attach your subwoofer. (On computers with a sound card, use the connector on the card.)
15	keyboard connector	If you have a standard keyboard, plug it into the purple keyboard connector. If you have a USB keyboard, plug it into a USB connector.
16	diagnostic lights (4)	Use the lights to help you troubleshoot a computer problem based on the diagnostic code. For more information, see page 43.
17	integrated video connector	If this connector has a protective cap over it, then your computer has the optional video card installed. If this connector does not have a protective cap over it, plug the cable from your monitor into the blue connector.
18	SPDIF-out connector	Use this connector to provide a digital audio signal to amplifiers, a mini-disc, and other SPDIF-in compatible equipment.

Reattaching the Front Door

To prevent damage to your computer, the front door is designed to "break away" if it is opened too far. To reattach the front door:

- 1 Shut down the computer through the **Start** menu (see page 21).
 - 2 Ensure that your computer and attached devices are turned off. If your computer and attached devices did not automatically turn off when you shut down your computer, turn them off now.
-  **NOTICE:** To disconnect a network cable, first unplug the cable from your computer and then unplug it from the network wall jack.
- 3 Disconnect any telephone or telecommunication lines from the computer.
 - 4 Disconnect your computer and all attached devices from their electrical outlets, and then press the power button to ground the system board.
-  **NOTE:** The top hinge arm clicks when it is moved to the closed position—the bottom hinge arm does not.
- 5 Move the hinge arms to the closed position.

- 6 Align the two clips on the inside of the front door with the two hinge arms.
- 7 Press inward on the front door until it clips to both hinge arms.

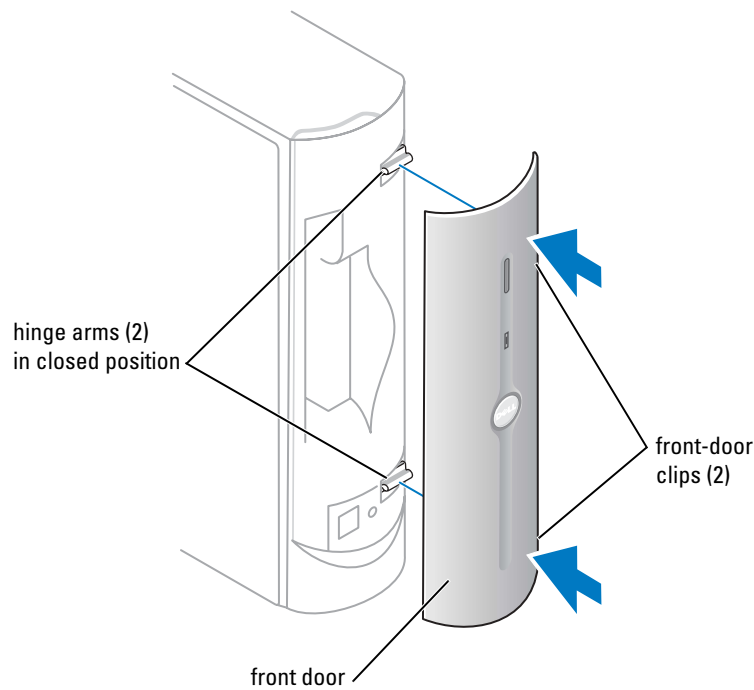

Opening the Computer Cover

CAUTION: Before you begin any of the procedures in this section, follow the safety instructions located in the *Product Information Guide*.

- 1 Shut down the computer through the **Start** menu (see page 21).
- 2 Ensure that your computer and attached devices are turned off. If your computer and attached devices did not automatically turn off when you shut down your computer, turn them off now.
- NOTICE:** To disconnect a network cable, first unplug the cable from your computer and then unplug it from the network wall jack.
- 3 Disconnect any telephone or telecommunication lines from the computer.
- 4 Disconnect your computer and all attached devices from their electrical outlets, and then press the power button to ground the system board.

5 Remove the computer stand, if it is attached (see page 12).

⚠ CAUTION: To guard against electrical shock, always unplug your computer from the electrical outlet before opening the cover.

👉 NOTICE: Ensure that there is sufficient space to support the open cover—at least 30 cm (1 ft) of desk top space.

6 Locate the *two* release buttons shown in the illustration. Then press the *two* release buttons as you lift the cover.



👉 NOTICE: Open the cover slowly to ensure that you do not damage any cables.

7 Raise the back of the cover, and pivot it toward the front of the computer.

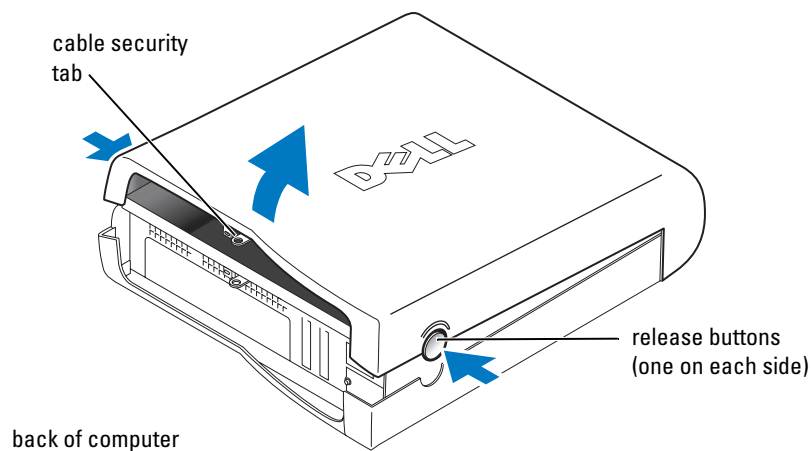
🖱 NOTE: Make sure that the computer is oriented with the cable security tab on top, as shown in the illustration.



Looking Inside Your Computer

-  **CAUTION:** Before you begin any of the procedures in this section, follow the safety instructions located in the *Product Information Guide*.
-  **CAUTION:** To guard against electrical shock, always unplug your computer from the electrical outlet before opening the cover.
-  **NOTICE:** Be careful when opening the computer cover to ensure that you do not inadvertently disconnect cables from the system board.

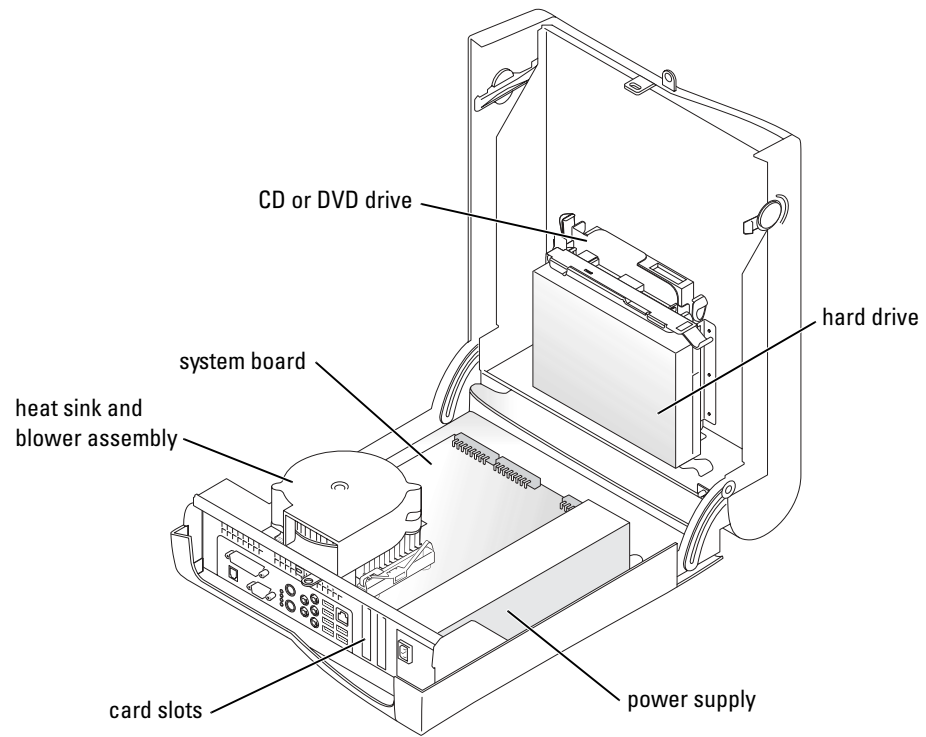

System Board

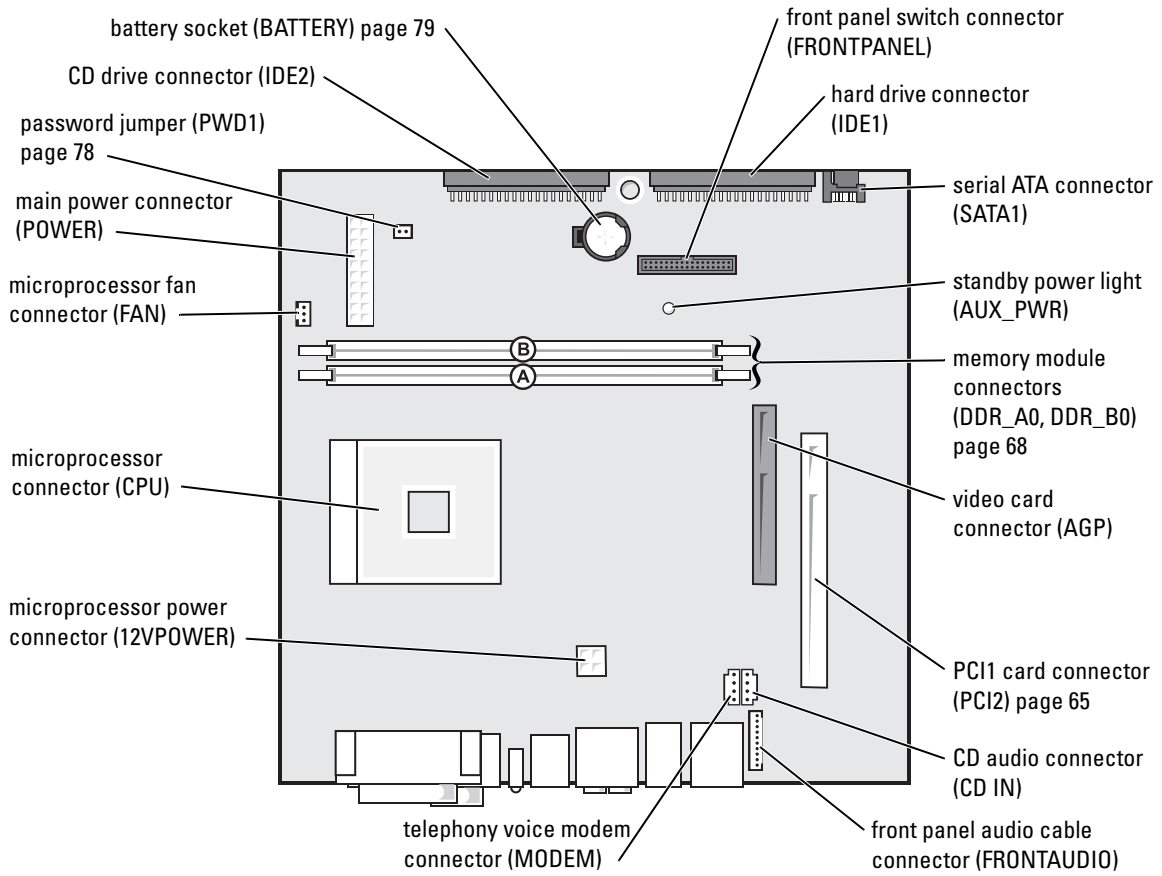

back of computer

Adding PC Cards (Optional)

 **CAUTION:** Before you begin any of the procedures in this section, follow the safety instructions located in the *Product Information Guide*.

You can add PC Cards to computers with integrated PC Card connectors.

PC Card Types

 **NOTE:** "Type" of card refers to its thickness, not its functionality.

The PC Card slot has two connectors that support the following four combinations of cards.

 **NOTE:** Your computer is designed for either 5-V or 3.3-V 16-bit PCMCIA cards. Some cards are keyed for 3.3 V only but will not fit into the PC slot. Cards are keyed to prevent incorrect insertion into the slot. If card orientation is not clear, see the documentation supplied with the card.

- A single Type I or Type II card (using either the upper or lower PC Card connector)
- One Type I card and one Type II card (using either connector)
- Two Type I cards or two Type II cards
- One Type III card (using the lower connector)

Both PC Card connectors support extended PC Cards.

Installing a PC Card

 **NOTE:** The length of some PC Cards may prevent the front-panel door from closing.

PC Cards are generally marked with a symbol (such as a triangle or an arrow) to indicate which end to insert into the slot, and the cards are keyed to prevent incorrect insertion. If card orientation is not clear, see the documentation supplied with the card.

- 1 Hold the card with its orientation symbol pointing into the slot and the top side of the card facing up.

 **NOTE:** A PC Card is not a bootable device.

- 2 Insert the card into the slot, and press firmly until the card is completely seated in the internal PC Card connector.

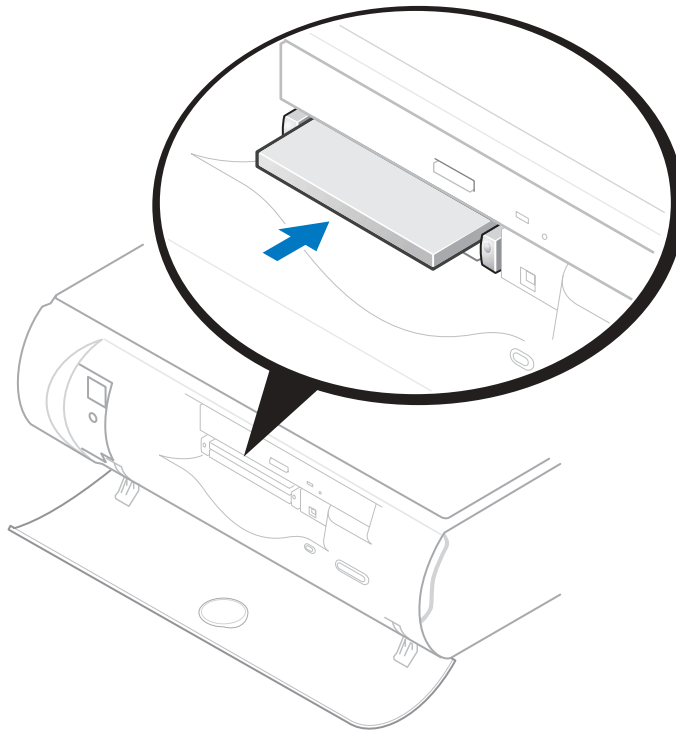

- 3 If you encounter too much resistance when you insert the card, do not force the card. Check the card's orientation, and try again.
- 4 Your computer recognizes most PC Cards and automatically loads the appropriate device driver for use with the computer. If the configuration program tells you to load the manufacturer's drivers, install them with the CD that accompanied the PC Card.

Removing a PC Card

➡ **NOTICE:** Use the PC Card configuration utility on the taskbar to select and stop a card from functioning before you remove it from the computer. If you do not remove the card in the configuration utility, you could lose data from open programs.

🔍 **NOTE:** Press the button with the upper dot to eject the top card and the button with the lower dot to eject the bottom card.

➡ **NOTICE:** Do not attempt to eject a card by pulling its dongle, if one is attached.

Press the eject button, and gently remove the card.

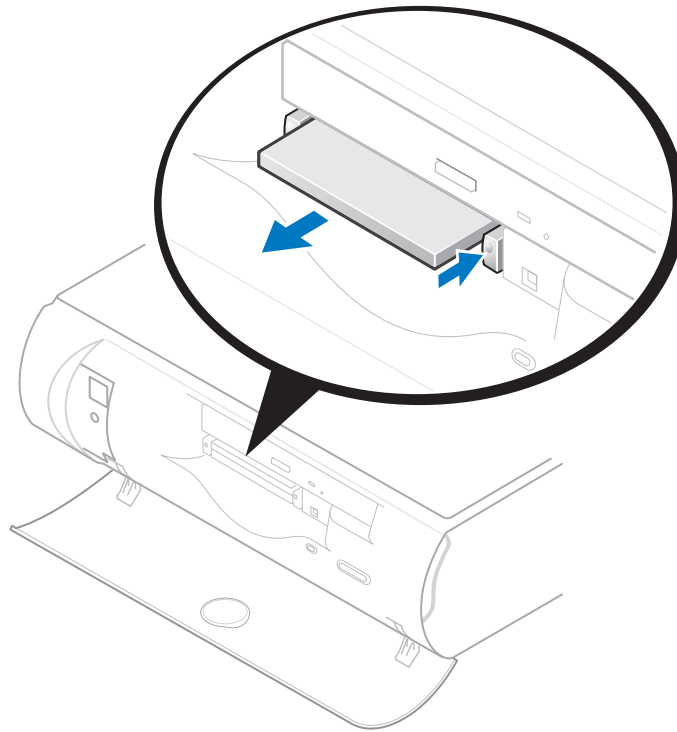

Adding Other Cards

 **CAUTION:** Before you begin any of the procedures in this section, follow the safety instructions located in the *Product Information Guide*.

 **NOTICE:** You must use low-profile cards for your computer. A full-size card can cause damage to the computer or the card.

The computer's card connectors allow you to install different types of devices such as modems and network adapters.

- 1 Shut down the computer through the **Start** menu (see page 21).
- 2 Ensure that your computer and attached devices are turned off. If your computer and attached devices did not automatically turn off when you shut down your computer, turn them off now.

 **NOTICE:** To disconnect a network cable, first unplug the cable from your computer and then unplug it from the network wall jack.

- 3 Disconnect any telephone or telecommunication lines from the computer.
- 4 Disconnect your computer and all attached devices from their electrical outlets, and then press the power button to ground the system board.
- 5 Remove the computer stand (see page 12).

 **CAUTION:** To guard against electrical shock, always unplug your computer from the electrical outlet before opening the cover.

- 6 Open the computer cover (see page 58).
- 7 Press the lever on the retention arm and raise the retention arm.
- 8 If you are installing a new card, remove the filler bracket to create an empty card-slot opening. If you are replacing a card that is already installed in the computer, remove the card. If necessary, disconnect any cables connected to the card. Grasp the card by its top corners, and ease it out of its connector.

- 9 Prepare the card for installation.



See the documentation that came with the card for information on configuring the card, making internal connections, or otherwise customizing it for your computer.

 **CAUTION:** Some network adapters automatically start the computer when they are connected to a network. To guard against electrical shock, be sure to unplug your computer from its electrical outlet before installing any cards.

- 10 Insert the card into the card connector.

If the card is full-length, insert the end of the card into the card guide bracket as you lower the card toward its connector on the system board. Insert the card firmly into the card connector on the riser board.

- 11 Lower the retention arm and press it into place, securing the card(s) in the computer.

- 12 Reconnect any cables that you previously removed.
- 13 Connect any cables that should be attached to the card.
See the documentation for the card for information about the card's cable connections.
-  **NOTICE:** Do not route card cables over or behind the cards. Cables routed over the cards can prevent the computer cover from closing properly or cause damage to the equipment.
- 14 Close the computer cover (see page 72).
- 15 Attach the computer stand (see page 12).
-  **NOTICE:** To connect a network cable, first plug the cable into the network wall jack and then plug it into the computer.
- 16 Connect your computer and devices to electrical outlets, and turn them on.
- 17 Install any drivers required for the card as described in the card documentation.

Adding or Replacing a Video Card

 **CAUTION:** Before you begin any of the procedures in this section, follow the safety instructions located in the *Product Information Guide*.

 **NOTE:** You must use low-profile cards for your computer. A full-size card can cause damage to the computer or the card.

Your Dell™ computer provides a connector for an AGP card.

- 1 Shut down the computer through the **Start** menu (see page 21).
- 2 Ensure that your computer and attached devices are turned off. If your computer and attached devices did not automatically turn off when you shut down your computer, turn them off now.

 **NOTICE:** To disconnect a network cable, first unplug the cable from your computer and then unplug it from the network wall jack.

- 3 Disconnect any telephone or telecommunication lines from the computer.
- 4 Disconnect your computer and all attached devices from their electrical outlets, and then press the power button to ground the system board.
- 5 Remove the computer stand (see page 12).

 **CAUTION:** To guard against electrical shock, always unplug your computer from the electrical outlet before opening the cover.

- 6 Open the computer cover (see page 58).

Removing a Video Card

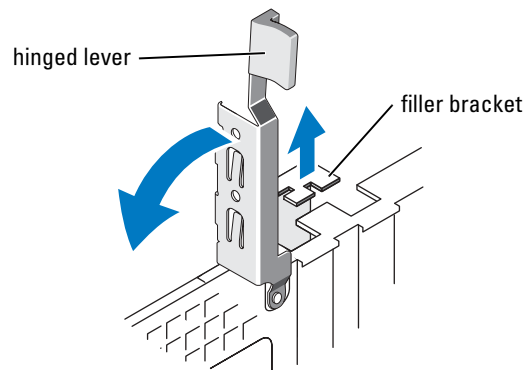

- 1 Remove the filler bracket by raising the hinged lever and sliding the filler bracket up.

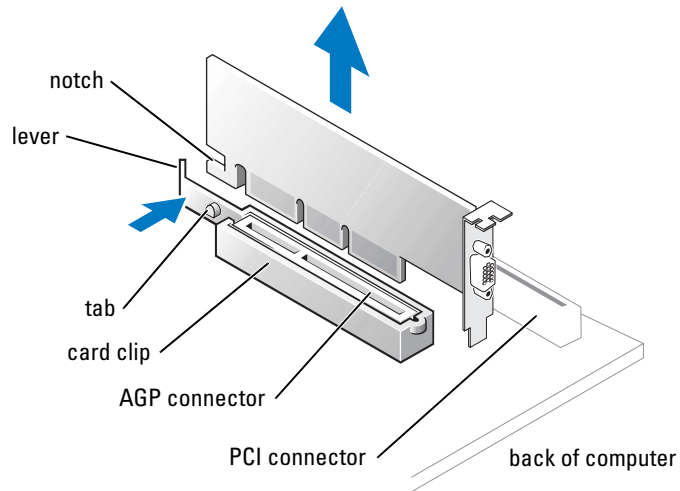

- 2 Press the card lever toward the PCI connector.
- 3 Pull the card up and out of the card clip.



Installing a Video Card

-  **NOTE:** If you purchased the optional video card, ensure that you connected your monitor cable to the correct video connector.
-  **NOTICE:** You must use low-profile cards for your computer. A full-size card can damage the computer or the card.
 - 1 To add or replace the card, press the card lever toward the PCI connector and gently press the card into the AGP connector until it clicks into place.
 - 2 Release the card lever, ensuring that the tab fits into the notch on the front end of the card.
 - 3 Secure the card by lowering the hinged lever on the back panel.
 - 4 Close the computer cover (see page 72).
 - 5 Attach the computer stand (see page 12).
 - 6 Connect the monitor cable to the card's video connector.
-  **NOTICE:** To connect a network cable, first plug the cable into the network wall jack and then plug it into the computer.
 - 7 Connect your computer and devices to electrical outlets, and turn them on.

Adding Memory

You can increase your computer memory by installing memory modules on the system board. For information on the type of memory supported by your computer, see "Memory" on page 74.

-  **NOTE:** DDR 333 memory operates at 320-MHz when used with an 800-MHz front-side bus.

DDR Memory Overview

DDR memory modules should be installed in *pairs of matched memory size*. This means that if you purchased your computer with 128 MB of memory installed and you want to add another 128 MB of memory, you should install it in the appropriate connector. If the DDR memory modules are not installed in matched pairs, the computer will continue to operate, but with a slight reduction in performance.

-  **NOTE:** Always install DDR memory modules in the order indicated on the system board.

The recommended memory configurations are:

- Install a pair of matched memory modules in connectors DDR_A0 and DDR_B0
- Do not install ECC memory modules.
- Be sure to install a single memory module in DDR_A0 or the connector closest to the processor before you install modules in the other connectors.

 **NOTICE:** If you remove your original memory modules from the computer during a memory upgrade, keep them separate from any new modules that you may have, even if you purchased the new modules from Dell. You should install your original memory modules in pairs in connectors DDR_A0 and DDR_B0. If possible, *do not* pair an original memory module with a new memory module. Otherwise, your computer may not function at optimal performance.

 **NOTE:** Memory purchased from Dell is covered under your computer warranty.

Installing Memory

 **CAUTION:** Before you begin any of the procedures in this section, follow the safety instructions located in the *Product Information Guide*.

- 1 Shut down the computer through the **Start** menu (see page 21).
- 2 Ensure that your computer and attached devices are turned off. If your computer and attached devices did not automatically turn off when you shut down your computer, turn them off now.

 **NOTICE:** To disconnect a network cable, first unplug the cable from your computer and then unplug it from the network wall jack.

- 3 Disconnect any telephone or telecommunication lines from the computer.
- 4 Disconnect your computer and all attached devices from their electrical outlets, and then press the power button to ground the system board.
- 5 Remove the computer stand (see page 12).

 **CAUTION:** To guard against electrical shock, always unplug your computer from the electrical outlet before opening the cover.

- 6 Open the computer cover (see page 58).

- 7 Press out the securing clip at each end of the memory module connector.

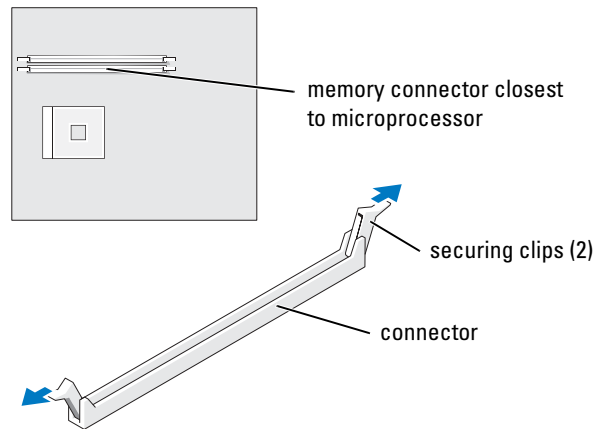

- 8 Align the notch on the bottom of the module with the crossbar in the connector.

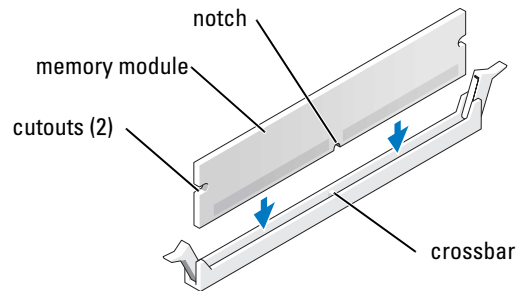

NOTICE: To avoid damage to the memory module, press the module straight down into the connector while you apply equal force to each end of the module.

- 9 Insert the module into the connector until the module snaps into position.

If you insert the module correctly, the securing clips snap into the cutouts at each end of the module.

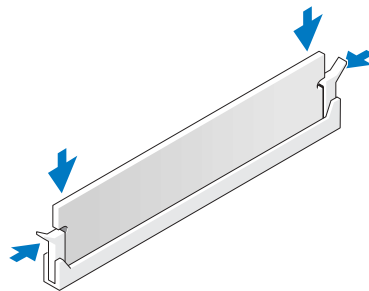

- 10 Close the computer cover (see page 72).
- 11 Attach the computer stand (see page 12).
-  **NOTICE:** To connect a network cable, first plug the cable into the network wall jack and then plug it into the computer.
- 12 Connect your computer and devices to electrical outlets, and turn them on.
- 13 Right-click the **My Computer** icon and click **Properties**.
- 14 Click the **General** tab.
- 15 To verify that the memory is installed correctly, check the amount of memory (RAM) listed.

Removing Memory

 **CAUTION:** Before you begin any of the procedures in this section, follow the safety instructions located in the *Product Information Guide*.

 **NOTE:** Memory purchased from Dell is covered under your computer warranty.

- 1 Shut down the computer through the **Start** menu (see page 21).
- 2 Ensure that your computer and attached devices are turned off. If your computer and attached devices did not automatically turn off when you shut down your computer, turn them off now.

 **NOTICE:** To disconnect a network cable, first unplug the cable from your computer and then unplug it from the network wall jack.

- 3 Disconnect any telephone or telecommunication lines from the computer.
- 4 Disconnect your computer and all attached devices from their electrical outlets, and then press the power button to ground the system board.
- 5 Remove the computer stand (see page 12).

 **CAUTION:** To guard against electrical shock, always unplug your computer from the electrical outlet before opening the cover.

- 6 Open the computer cover (see page 58).
- 7 Press out the securing clip at each end of the memory module connector.
- 8 Grasp the module and pull up.

If the module is difficult to remove, gently ease the module back and forth to remove it from the connector.

Closing the Computer Cover

- 1 Ensure that all cables are connected, and fold cables out of the way.
Gently pull the power cables toward you so that they do not get caught underneath the drives.
- 2 Ensure that no tools or extra parts are left inside the computer.
- 3 Close the cover:
 - a Pivot the cover down.
 - b Press down on the right side of the cover until it closes.
 - c Press down on the left side of the cover until it closes.
 - d Ensure that both sides of the cover are locked. If not, repeat step 3.
-  **NOTICE:** To connect a network cable, first plug the cable into the network wall jack and then plug it into the computer.
- 4 Connect your computer and devices to electrical outlets, and turn them on.

Appendix

Specifications

Microprocessor

Microprocessor type	Intel® Pentium® 4
L1 cache	8 KB first-level
L2 cache	256-KB, 512-KB, or 1-MB pipelined-burst, eight-way set associative, write-back SRAM

System Information

System chip set	Intel 865G
DMA channels	four
Interrupt levels	24 APIC mode
System BIOS chip	4 Mb (512 KB)
System clock	400-, 533-, or 800-MHz data rate

Expansion Bus

Bus types	PCI and AGP
Bus speed	PCI: 33 MHz
AGP	AGP 1X, 4X, 8X
AGP connector	one low profile
AGP connector size	172 pins
AGP connector data width (maximum)	32 bits
AGP video bus protocols	4x modes at 1.5 V
PCI connectors	one low profile
PCI connector size	120 pins
PCI connector data width (maximum)	32 bits

Memory	
Architecture	DDR SDRAM
Memory connectors	two
Memory capacities	128-, 256-, 512-MB, and 1-GB non-ECC DDR SDRAM
Minimum memory	256 MB
Maximum memory	2 GB
Memory type	333-MHz DDR SDRAM (non-ECC)
Drives	
Externally accessible	one slimline optical bay one slimline 3.5-inch bay
Internally accessible	one bay for 1-inch-high IDE hard drive
Ports and Connectors	
Externally accessible:	
Parallel	25-pin connector (bidirectional)
IEEE 1394	two 4-hole, unpowered connectors
Video	15-pin connector
Keyboard	6-pin mini-DIN connector or USB connector
Mouse	6-pin mini-DIN connector or USB connector
USB	two front-panel and six back-panel USB 2.0-compliant connectors
Headphone	front-panel miniature connector for line-out
Audio	five back miniature connectors for line-in, line-out, microphone, and surround and center/LFE channel
Network	RJ-45 connector
Internally accessible:	
Primary IDE channel	40-pin connector on PCI local bus
Secondary IDE channel	40-pin connector on PCI local bus
Serial ATA	one 7-pin connector
Video	
Video controller	Intel-integrated AGP graphics (low-profile AGP video card also supported) - 4X and 8X

Audio

Audio controller	ADI 1980
------------------	----------

Network

Network controller	integrated 10/100 Ethernet
--------------------	----------------------------

Controls and Lights

Power control	push button
---------------	-------------

Power light	green light on power button—blinking green in sleep state; solid green for power-on state
-------------	--

Hard-drive access light	green
-------------------------	-------

Diagnostic code lights	four bicolor (amber and green) located on back panel
------------------------	--

Power

DC power supply:

Wattage	160 W
---------	-------

Heat dissipation	546 BTU (fully loaded computer without monitor)
------------------	---

Voltage (see the <i>Product Information Guide</i> for important voltage setting information)	90 to 135 V at 50/60 Hz; 180 to 265 V at 50/60 Hz; 100 V at 50/60 Hz for Japanese computers
--	---

Backup battery	3-V CR2032 coin cell
----------------	----------------------

Physical

Height x Width x Depth	32.3 x 9.5 x 35.6 cm (12.7 x 3.8 x 14.0 inches)
------------------------	---

(With stand)	33.8 x 18.0 x 35.6 cm (13.3 x 7.1 x 14.0 inches)
--------------	--

Weight	7.43 kg (16.4 lb)
--------	-------------------

Environmental

Temperature:

Operating

10° to 35°C (50° to 95°F)

NOTE: At 35°C (95°F), the maximum operating altitude is 914 m (3000 ft).

Storage

-40° to 65°C (-40° to 149°F)

Relative humidity

20% to 80% (noncondensing)

Maximum vibration:

Operating

0.25 G at 3 to 200 Hz at 1/2 octave/min

Storage

0.5 G at 3 to 200 Hz at 1/2 octave/min

Maximum shock:

Operating

bottom half-sine pulse with a change in velocity of 50.8 cm/sec (20 inches/sec)

Storage

23-G faired-square wave with a velocity change of 508 cm/sec (200 inches/sec)

Altitude:

Operating

-15.2 to 3048 m (-50 to 10,000 ft)

NOTE: At 35°C (95°F), the maximum operating altitude is 914 m (3000 ft).

Storage

-15.2 to 10,670 m (-50 to 35,000 ft)

Standard Settings

The system setup program contains the standard settings for your computer.

 **NOTICE:** Unless you are an expert computer user, do not change the settings for this program. Certain changes might make your computer work incorrectly.

See the following figure for an example of the main program screen.

Bell - Dimension 4600C			
Intel® Pentium® 4 Processor: <i>### GHz</i>	BIOS Version: <i>###</i>		
Level 2 Cache: <i>### KB Integrated</i>	Service Tag: <i>#####</i>		
<pre> System Time00:00:00 System DateDAY/MO/DATE/YR Drive Configuration<Enter> Boot Sequence<Enter> Hard-Disk Drive Sequence<Enter> Memory Information<Enter> CPU Information<Enter> Integrated Devices (LegacySelect Options)<Enter> Power Management<Enter> System Security<Enter> Keyboard NumLockOn Report Keyboard ErrorsReport Auto Power OnDisabled Fast BootOn OS Install ModeOff IDE Hard Drive Acoustics ModeBypass System Event Log<Enter> Asset Tag##### </pre>			
↓↑ to select	SPACE, +, - to change	ESC to exit	F1 = Help

Viewing Settings

- 1 Turn on (or restart) your computer.
- 2 When the blue DELL™ logo appears, press <F2> immediately.
If you wait too long and the operating system logo appears, continue to wait until you see the Microsoft® Windows® desktop. Then shut down your computer and try again.

System Setup Screens

The system setup program screens display the current configuration information for your computer. Information on the screen is divided into five areas:

- Title — The box at the top of all screens that lists the computer name.
- Computer data — Two boxes below the title box that display your computer processor, L2 cache, service tag, and the version number of the BIOS.
- Options — A scrollable box listing options that define the configuration of your computer, including installed hardware, power conservation, and security features.

Fields to the right of the option titles contain settings or values. The fields that you can change appear bright on the screen. The fields that you cannot change (because they are set by the computer) appear less bright. When <Enter> appears to the right of an option title, press <Enter> to access a popup menu of additional options.

- Key functions — A line of boxes across the bottom of all screens that lists keys and their functions within system setup.
- Help — Press <F1> for information on the option that is selected (highlighted).

Clearing Forgotten Passwords





CAUTION: Before you begin any of the procedures in this section, follow the safety instructions in the *Product Information Guide*.

If you forget your user or setup password, you cannot operate your computer or change settings in the system setup program until you clear the forgotten password(s).



NOTICE: This process erases both the system and setup passwords.

- 1 Shut down the computer (see page 21).
- 2 Turn off any attached devices and disconnect them from their electrical outlets.
- 3 Disconnect the computer power cable from the wall outlet, and then press the power button to ground the system board.
- 4 Remove the computer stand (see page 13).
- 5 Open the computer cover (see page 58).

- 6 Locate jumper PSWD on the system board (see page 61) and remove the jumper plug.
- 7 Close the computer cover (see page 72), plug your computer into an electrical outlet, and turn on the computer.
The existing password(s) will be erased.
- 8 Shut down the computer (see page 21).
-  **NOTICE:** To disconnect a network cable, first unplug the cable from your computer and then unplug it from the network wall jack.
- 9 Turn off any attached devices and disconnect them from their electrical outlets.
- 10 Disconnect the computer power cable from the wall outlet, and then press the power button to ground the system board.
- 11 Open the computer cover (see page 58).
- 12 Reconnect the jumper plug to jumper PSWD (see page 61).
- 13 Close the computer cover (see page 72).
- 14 Attach the computer stand (see page 12).
-  **NOTICE:** To connect a network cable, first plug the cable into the network wall jack and then plug it into the computer.
- 15 Connect your computer and devices to electrical outlets, and turn them on.
Turning on your computer with the PSWD jumper installed reenables the password feature.

Replacing the Battery

 **CAUTION:** Before you begin any of the procedures in this section, follow the safety instructions located in the *Product Information Guide*.

A coin-cell battery maintains computer configuration, date, and time information. The battery can last several years.

If you have to repeatedly reset time and date information after turning on the computer, replace the battery.

 **CAUTION:** A new battery can explode if it is incorrectly installed. Replace the battery only with the same or equivalent type recommended by the manufacturer. Discard used batteries according to the manufacturer's instructions.

To replace the battery:

- 1 Record all the screens in the system setup program (see page 78) so that you can restore the correct settings in step 14.
- 2 Shut down the computer through the Start menu (see page 21).

- 3 Ensure that your computer and attached devices are turned off. If your computer and attached devices did not automatically turn off when you shut down your computer, turn them off now.
- ➡ **NOTICE:** To disconnect a network cable, first unplug the cable from your computer and then unplug it from the network wall jack.
- 4 Disconnect any telephone or telecommunication lines from the computer.
- 5 Disconnect your computer and all attached devices from electrical outlets, and then press the power button to ground the system board.
- 6 Remove the computer stand (see page 12).
- ⚠ **CAUTION:** To guard against electrical shock, always unplug your computer from the electrical outlet before opening the cover.
- 7 Open the computer cover (see page 58).
- ➡ **NOTICE:** Before touching anything inside your computer, ground yourself by touching an unpainted metal surface, such as the metal at the back of the computer. While you work, periodically touch an unpainted metal surface to dissipate any static electricity that could harm internal components.
- 8 Locate the battery socket (see page 61).
- ➡ **NOTICE:** If you pry the battery out of its socket with a blunt object, be careful not to touch the system board with the object. Ensure that the object is inserted between the battery and the socket before you attempt to pry out the battery. Otherwise, you may damage the system board by prying off the socket or by breaking circuit traces on the system board.
- 9 Remove the battery by carefully prying it out of its socket with your fingers or with a blunt, nonconducting object such as a plastic screwdriver.
- 10 Insert the new battery into the socket with the side labeled "+" facing up, and snap the battery into place.

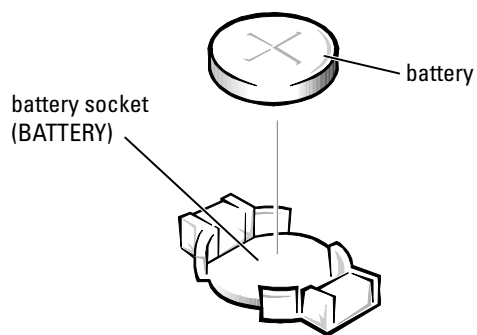

- 11 Close the computer cover.
- 12 Attach the computer stand (see page 12).

 **NOTICE:** To connect a network cable, first plug the cable into the network wall jack and then plug it into the computer.

- 13 Connect your computer and devices to electrical outlets, and turn them on.
- 14 Enter the system setup program (see page 78) and restore the settings you recorded in step 1.
- 15 Properly dispose of the old battery (see the *Product Information Guide*).

Dell Technical Support Policy (U.S. Only)

Technician-assisted technical support requires the cooperation and participation of the customer in the troubleshooting process and provides for restoration of the operating system, software programs, and hardware drivers to the original default configuration as shipped from Dell, as well as the verification of appropriate functionality of the computer and all Dell-installed hardware. In addition to this technician-assisted technical support, online technical support is available at support.dell.com. Additional technical support options may be available for purchase.

Dell provides limited technical support for the computer and any "Dell-installed" software and peripherals¹. Support for third-party software and peripherals is provided by the original manufacturer, including those purchased and/or installed through Dell Software and Peripherals, Readyware, and Custom Factory Integration².

¹ Repair services are provided pursuant to the terms and conditions of your limited warranty and any optional support service contract purchased with the computer.

² All Dell-standard components included in a Custom Factory Integration (CFI) project are covered by the standard Dell limited warranty for your computer. However, Dell also extends a parts replacement program to cover all nonstandard, third-party hardware components integrated through CFI for the duration of the computer's service contract.

Definition of "Dell-Installed" Software and Peripherals

Dell-installed software includes the operating system and some of the software program that is installed on the computer during the manufacturing process (Microsoft Office, Norton Antivirus, and so on).

Dell-installed peripherals include any internal expansion cards, or Dell-branded module bay or PC Card accessories. In addition, any Dell-branded monitors, keyboards, mice, speakers, microphones for telephonic modems, docking stations/port replicators, networking products, and all associated cabling are included.

Definition of "Third-Party" Software and Peripherals

Third-party software and peripherals include any peripheral, accessory, or software program sold by Dell not under the Dell brand (printers, scanners, cameras, games, and so on). Support for all third-party software and peripherals is provided by the original manufacturer of the product.

FCC Notices (U.S. Only)

Most Dell computer systems are classified by the Federal Communications Commission (FCC) as Class B digital devices. To determine which classification applies to your computer system, examine all FCC registration labels located on the bottom, side, or back panel of your computer, on card-mounting brackets, and on the cards themselves. If any one of the labels carries a Class A rating, your entire system is considered to be a Class A digital device. If *all* labels carry an FCC Class B rating as distinguished by either an FCC ID number or the FCC logo, (**FC**), your system is considered to be a Class B digital device.

Once you have determined your system's FCC classification, read the appropriate FCC notice. Note that FCC regulations provide that changes or modifications not expressly approved by Dell could void your authority to operate this equipment.

This device complies with Part 15 of the FCC Rules. Operation is subject to the following two conditions:

This device may not cause harmful interference.

This device must accept any interference received, including interference that may cause undesired operation.

Class A

This equipment has been tested and found to comply with the limits for a Class A digital device pursuant to Part 15 of the FCC Rules. These limits are designed to provide reasonable protection against harmful interference when the equipment is operated in a commercial environment. This equipment generates, uses, and can radiate radio frequency energy and, if not installed and used in accordance with the manufacturer's instruction manual, may cause harmful interference with radio communications. Operation of this equipment in a residential area is likely to cause harmful interference, in which case you will be required to correct the interference at your own expense.

Class B

This equipment has been tested and found to comply with the limits for a Class B digital device pursuant to Part 15 of the FCC Rules. These limits are designed to provide reasonable protection against harmful interference in a residential installation. This equipment generates, uses, and can radiate radio frequency energy and, if not installed and used in accordance with the manufacturer's instruction manual, may cause interference with radio communications. However, there is no guarantee that interference will not occur in a particular installation. If this equipment does cause harmful interference to radio or television reception, which can be determined by turning the equipment off and on, you are encouraged to try to correct the interference by one or more of the following measures:

- Reorient or relocate the receiving antenna.
- Increase the separation between the equipment and the receiver.

- Connect the equipment into an outlet on a circuit different from that to which the receiver is connected.
- Consult the dealer or an experienced radio/television technician for help.

FCC Identification Information

The following information is provided on the device or devices covered in this document in compliance with FCC regulations:

- Model number: DHP
Company name:

Dell Inc.
One Dell Way
Round Rock, Texas 78682 USA
512-338-4400

Contacting Dell

To contact Dell electronically, you can access the following websites:

- www.dell.com
- support.dell.com (technical support)
- premiersupport.dell.com (technical support for educational, government, healthcare, and medium/large business customers, including Premier, Platinum, and Gold customers)

For specific web addresses for your country, find the appropriate country section in the table below.

NOTE: Toll-free numbers are for use within the country for which they are listed.

When you need to contact Dell, use the electronic addresses, telephone numbers, and codes provided in the following table. If you need assistance in determining which codes to use, contact a local or an international operator.

Country (City) International Access Code Country Code City Code	Department Name or Service Area, Website and E-Mail Address	Area Codes, Local Numbers, and Toll-Free Numbers
Anguilla	General Support	toll-free: 800-335-0031
Antigua and Barbuda	General Support	1-800-805-5924

Country (City) International Access Code Country Code City Code	Department Name or Service Area, Website and E-Mail Address	Area Codes, Local Numbers, and Toll-Free Numbers
Argentina (Buenos Aires) International Access Code: 00 Country Code: 54 City Code: 11	Website: www.dell.com.ar E-mail: us_latin_services@dell.com E-mail for desktop and portable computers: la-techsupport@dell.com E-mail for servers and EMC: la_enterprise@dell.com Customer Care Tech Support Tech Support Services Sales	toll-free: 0-800-444-0730 toll-free: 0-800-444-0733 toll-free: 0-800-444-0724 0-810-444-3355
Aruba	General Support	toll-free: 800-1578
Australia (Sydney) International Access Code: 0011 Country Code: 61 City Code: 2	E-mail (Australia): au_tech_support@dell.com E-mail (New Zealand): nz_tech_support@dell.com Home and Small Business Government and Business Preferred Accounts Division (PAD) For servers and storage For desktop and portable computers Customer Care Corporate Sales Transaction Sales Fax	1-300-65-55-33 toll-free: 1-800-633-559 toll-free: 1-800-060-889 toll-free: 1-800-505-095 toll-free: 1-800-733-314 toll-free: 1-800-819-339 toll-free: 1-800-808-385 toll-free: 1-800-808-312 toll-free: 1-800-818-341
Austria (Vienna) International Access Code: 900 Country Code: 43 City Code: 1	Website: support.euro.dell.com E-mail: tech_support_central_europe@dell.com Home/Small Business Sales Home/Small Business Fax Home/Small Business Customer Care Preferred Accounts/Corporate Customer Care Home/Small Business Technical Support Preferred Accounts/Corporate Technical Support Switchboard	0820 240 530 00 0820 240 530 49 0820 240 530 14 0820 240 530 16 0820 240 530 14 0660 8779 0820 240 530 00
Bahamas	General Support	toll-free: 1-866-278-6818

Country (City) International Access Code Country Code City Code	Department Name or Service Area, Website and E-Mail Address	Area Codes, Local Numbers, and Toll-Free Numbers
Barbados	General Support	1-800-534-3066
Belgium (Brussels)	Website: support.euro.dell.com	
International Access Code: 00	E-mail for French Speaking Customers: support.euro.dell.com/be/fr/emaidell/	
Country Code: 32	Technical Support	02 481 92 88
City Code: 2	Technical Support Fax	02 481 92 95
	Customer Care	02 713 15 .65
	Corporate Sales	02 481 91 00
	Fax	02 481 92 99
	Switchboard	02 481 91 00
Bermuda	General Support	1-800-342-0671
Bolivia	General Support	toll-free: 800-10-0238
Brazil	Website: www.dell.com/br	
International Access Code: 00	Customer Support, Technical Support	0800 90 3355
Country Code: 55	Technical Support Fax	51 481 5470
City Code: 51	Customer Care Fax	51 481 5480
	Sales	0800 90 3390
British Virgin Islands	General Support	toll-free: 1-866-278-6820
Brunei	Customer Technical Support (Penang, Malaysia)	604 633 4966
Country Code: 673	Customer Service (Penang, Malaysia)	604 633 4949
	Transaction Sales (Penang, Malaysia)	604 633 4955
Canada (North York, Ontario)	Online Order Status: www.dell.ca/ostatus	
International Access Code: 011	AutoTech (automated technical support)	toll-free: 1-800-247-9362
	Customer Care (Home Sales/Small Business)	toll-free: 1-800-847-4096
	Customer Care (med./large business, government)	toll-free: 1-800-326-9463
	Technical Support (Home Sales/Small Business)	toll-free: 1-800-847-4096
	Technical Support (med./large bus., government)	toll-free: 1-800-387-5757
	Sales (Home Sales/Small Business)	toll-free: 1-800-387-5752
	Sales (med./large bus., government)	toll-free: 1-800-387-5755
	Spare Parts Sales & Extended Service Sales	1 866 440 3355
Cayman Islands	General Support	1-800-805-7541

Country (City) International Access Code Country Code City Code	Department Name or Service Area, Website and E-Mail Address	Area Codes, Local Numbers, and Toll-Free Numbers
Chile (Santiago) Country Code: 56 City Code: 2	Sales, Customer Support, and Technical Support	toll-free: 1230-020-4823
China (Xiamen) Country Code: 86 City Code: 592	Technical Support website: support.dell.com.cn Technical Support E-mail: cn_support@dell.com Technical Support Fax Technical Support (Dimension™ and Inspiron™) Technical Support (OptiPlex™, Latitude™, and Dell Precision™) Technical Support (servers and storage) Technical Support (projectors, PDAs, printers, switches, routers, and so on) Customer Advocacy Customer Advocacy Fax Home and Small Business Preferred Accounts Division Large Corporate Accounts GCP Large Corporate Accounts Key Accounts Large Corporate Accounts North Large Corporate Accounts North Government and Education Large Corporate Accounts East Large Corporate Accounts East Government and Education Large Corporate Accounts Queue Team Large Corporate Accounts South Large Corporate Accounts West Large Corporate Accounts Spare Parts	818 1350 toll-free: 800 858 2969 toll-free: 800 858 0950 toll-free: 800 858 0960 toll-free: 800 858 2920 toll-free: 800 858 2060 592 818 1308 toll-free: 800 858 2222 toll-free: 800 858 2557 toll-free: 800 858 2055 toll-free: 800 858 2628 toll-free: 800 858 2999 toll-free: 800 858 2955 toll-free: 800 858 2020 toll-free: 800 858 2669 toll-free: 800 858 2572 toll-free: 800 858 2355 toll-free: 800 858 2811 toll-free: 800 858 2621
Colombia	General Support	980-9-15-3978
Costa Rica	General Support	0800-012-0435

Country (City) International Access Code Country Code City Code	Department Name or Service Area, Website and E-Mail Address	Area Codes, Local Numbers, and Toll-Free Numbers
Czech Republic (Prague)	Website: support.euro.dell.com	
International Access Code: 00	E-mail: czech_dell@dell.com	
Country Code: 420	Technical Support	02 2186 27 27
City Code: 2	Technical Support Fax	02 2186 27 28
	Customer Care	02 2186 27 11
	Customer Care Fax	02 2186 27 14
	Switchboard	02 2186 27 11
Denmark (Copenhagen)	Website: support.euro.dell.com	
International Access Code: 00	E-mail Support (portable computers): den_nbk_support@dell.com	
Country Code: 45	E-mail Support (desktop computers): den_support@dell.com	
	E-mail Support (servers): Nordic_server_support@dell.com	
	Technical Support	7023 0182
	Customer Care (Relational)	7023 0184
	Home/Small Business Customer Care	3287 5505
	Switchboard (Relational)	3287 1200
	Switchboard Fax (Relational)	3287 1201
	Switchboard (Home/Small Business)	3287 5000
	Switchboard Fax (Home/Small Business)	3287 5001
Dominica	General Support	toll-free: 1-866-278-6821
Dominican Republic	General Support	1-800-148-0530
Ecuador	General Support	toll-free: 999-119
El Salvador	General Support	01-899-753-0777

Country (City) International Access Code Country Code City Code	Department Name or Service Area, Website and E-Mail Address	Area Codes, Local Numbers, and Toll-Free Numbers
Finland (Helsinki)	Website: support.euro.dell.com	
International Access Code: 990	E-mail: fin_support@dell.com	
Country Code: 358	E-mail Support (servers): Nordic_support@dell.com	
City Code: 9	Technical Support	09 253 313 60
	Technical Support Fax	09 253 313 81
	Relational Customer Care	09 253 313 38
	Home/Small Business Customer Care	09 693 791 94
	Fax	09 253 313 99
	Switchboard	09 253 313 00
France (Paris) (Montpellier)	Website: support.euro.dell.com	
International Access Code: 00	E-mail: support.euro.dell.com/fr/fr/emaildell/	
Country Code: 33	Home and Small Business	
City Codes: (1) (4)	Technical Support	0825 387 270
	Customer Care	0825 823 833
	Switchboard	0825 004 700
	Switchboard (calls from outside of France)	04 99 75 40 00
	Sales	0825 004 700
	Fax	0825 004 701
	Fax (calls from outside of France)	04 99 75 40 01
	Corporate	
	Technical Support	0825 004 719
	Customer Care	0825 338 339
	Switchboard	01 55 94 71 00
	Sales	01 55 94 71 00
	Fax	01 55 94 71 01

Country (City) International Access Code Country Code City Code	Department Name or Service Area, Website and E-Mail Address	Area Codes, Local Numbers, and Toll-Free Numbers
Germany (Langen) International Access Code: 00 Country Code: 49 City Code: 6103	Website: support.euro.dell.com E-mail: tech_support_central_europe@dell.com Technical Support Home/Small Business Customer Care Global Segment Customer Care Preferred Accounts Customer Care Large Accounts Customer Care Public Accounts Customer Care Switchboard	06103 766-7200 0180-5-224400 06103 766-9570 06103 766-9420 06103 766-9560 06103 766-9555 06103 766-7000
Greece International Access Code: 00 Country Code: 30	Website: support.euro.dell.com E-mail: support.euro.dell.com/gr/en/emailldell/ Technical Support Gold Service Technical Support Switchboard Gold Service Switchboard Sales Fax	00800-44 14 95 18 00800-44 14 00 83 2108129810 2108129811 2108129800 2108129812
Grenada	General Support	toll-free: 1-866-540-3355
Guatemala	General Support	1-800-999-0136
Guyana	General Support	toll-free: 1-877-270-4609

Country (City) International Access Code Country Code City Code	Department Name or Service Area, Website and E-Mail Address	Area Codes, Local Numbers, and Toll-Free Numbers
Hong Kong	Website: support.ap.dell.com	
International Access Code: 001	E-mail: apsupport@dell.com	
Country Code: 852	Technical Support (Dimension™ and Inspiron™)	2969 3188
	Technical Support (OptiPlex™, Latitude™, and Dell Precision™)	2969 3191
	Technical Support (PowerApp™, PowerEdge™, PowerConnect™, and PowerVault™)	2969 3196
	Gold Queue EEC Hotline	2969 3187
	Customer Advocacy	3416 0910
	Large Corporate Accounts	3416 0907
	Global Customer Programs	3416 0908
	Medium Business Division	3416 0912
	Home and Small Business Division	2969 3155
India	Technical Support	1600 33 8045
	Sales	1600 33 8044
Ireland (Cherrywood)	Website: support.euro.dell.com	
International Access Code: 16	E-mail: dell_direct_support@dell.com	
Country Code: 353	Technical Support	1850 543 543
City Code: 1	U.K. Technical Support (dial within U.K. only)	0870 908 0800
	Home User Customer Care	01 204 4014
	Small Business Customer Care	01 204 4014
	U.K. Customer Care (dial within U.K. only)	0870 906 0010
	Corporate Customer Care	1850 200 982
	Corporate Customer Care (dial within U.K. only)	0870 907 4499
	Ireland Sales	01 204 4444
	U.K. Sales (dial within U.K. only)	0870 907 4000
	Fax/Sales Fax	01 204 0103
	Switchboard	01 204 4444

Country (City) International Access Code Country Code City Code	Department Name or Service Area, Website and E-Mail Address	Area Codes, Local Numbers, and Toll-Free Numbers
Italy (Milan)	Website: support.euro.dell.com	
International Access Code: 00	E-mail: support.euro.dell.com/it/it/emaildell/	
Country Code: 39	Home and Small Business	
City Code: 02	Technical Support	02 577 826 90
	Customer Care	02 696 821 14
	Fax	02 696 821 13
	Switchboard	02 696 821 12
	Corporate	
	Technical Support	02 577 826 90
	Customer Care	02 577 825 55
	Fax	02 575 035 30
	Switchboard	02 577 821
Jamaica	General Support (dial from within Jamaica only)	1-800-682-3639

Country (City) International Access Code Country Code City Code	Department Name or Service Area, Website and E-Mail Address	Area Codes, Local Numbers, and Toll-Free Numbers
Japan (Kawasaki)	Website: support.jp.dell.com	
International Access Code: 001	Technical Support (servers)	toll-free: 0120-198-498
Country Code: 81	Technical Support outside of Japan (servers)	81-44-556-4162
City Code: 44	Technical Support (Dimension™ and Inspiron™)	toll-free: 0120-198-226
	Technical Support outside of Japan (Dimension and Inspiron)	81-44-520-1435
	Technical Support (Dell Precision™, OptiPlex™, and Latitude™)	toll-free: 0120-198-433
	Technical Support outside of Japan (Dell Precision, OptiPlex, and Latitude)	81-44-556-3894
	Technical Support (PDAs, projectors, printers, routers)	toll-free: 0120-981-690
	Technical Support outside of Japan (PDAs, projectors, printers, routers)	81-44-556-3468
	Faxbox Service	044-556-3490
	24-Hour Automated Order Service	044-556-3801
	Customer Care	044-556-4240
	Business Sales Division (up to 400 employees)	044-556-1465
	Preferred Accounts Division Sales (over 400 employees)	044-556-3433
	Large Corporate Accounts Sales (over 3500 employees)	044-556-3430
	Public Sales (government agencies, educational institutions, and medical institutions)	044-556-1469
	Global Segment Japan	044-556-3469
	Individual User	044-556-1760
	Switchboard	044-556-4300
Korea (Seoul)	Technical Support	toll-free: 080-200-3800
International Access Code: 001	Sales	toll-free: 080-200-3600
Country Code: 82	Customer Service (Seoul, Korea)	toll-free: 080-200-3800
City Code: 2	Customer Service (Penang, Malaysia)	604 633 4949
	Fax	2194-6202
	Switchboard	2194-6000

Country (City) International Access Code Country Code City Code	Department Name or Service Area, Website and E-Mail Address	Area Codes, Local Numbers, and Toll-Free Numbers
Latin America	Customer Technical Support (Austin, Texas, U.S.A.)	512 728-4093
	Customer Service (Austin, Texas, U.S.A.)	512 728-3619
	Fax (Technical Support and Customer Service) (Austin, Texas, U.S.A.)	512 728-3883
	Sales (Austin, Texas, U.S.A.)	512 728-4397
	SalesFax (Austin, Texas, U.S.A.)	512 728-4600 or 512 728-3772
Luxembourg	Website: support.euro.dell.com	
International Access Code: 00	E-mail: tech_be@dell.com	
Country Code: 352	Technical Support (Brussels, Belgium)	3420808075
	Home/Small Business Sales (Brussels, Belgium)	toll-free: 080016884
	Corporate Sales (Brussels, Belgium)	02 481 91 00
	Customer Care (Brussels, Belgium)	02 481 91 19
	Fax (Brussels, Belgium)	02 481 92 99
	Switchboard (Brussels, Belgium)	02 481 91 00
Macao	Technical Support	toll-free: 0800 582
Country Code: 853	Customer Service (Penang, Malaysia)	604 633 4949
	Transaction Sales	toll-free: 0800 581
Malaysia (Penang)	Technical Support (Dell Precision, OptiPlex, and Latitude)	toll-free: 1 800 88 0193
International Access Code: 00		
Country Code: 60	Technical Support (Dimension and Inspiron)	toll-free: 1 800 88 1306
City Code: 4	Technical Support (PowerEdge and PowerVault)	toll-free: 1800 88 1386
	Customer Service	04 633 4949
	Transaction Sales	toll-free: 1 800 888 202
	Corporate Sales	toll-free: 1 800 888 213

Country (City) International Access Code Country Code City Code	Department Name or Service Area, Website and E-Mail Address	Area Codes, Local Numbers, and Toll-Free Numbers
Mexico International Access Code: 00 Country Code: 52	Customer Technical Support Sales Customer Service Main	001-877-384-8979 or 001-877-269-3383 50-81-8800 or 01-800-888-3355 001-877-384-8979 or 001-877-269-3383 50-81-8800 or 01-800-888-3355
Montserrat	General Support	toll-free: 1-866-278-6822
Netherlands Antilles	General Support	001-800-882-1519
Netherlands (Amsterdam) International Access Code: 00 Country Code: 31 City Code: 20	Website: support.euro.dell.com Technical Support Technical Support Fax Home/Small Business Customer Care Relational Customer Care Home/Small Business Sales Relational Sales Home/Small Business Sales Fax Relational Sales Fax Switchboard Switchboard Fax	020 674 45 00 020 674 47 66 020 674 42 00 020 674 4325 020 674 55 00 020 674 50 00 020 674 47 75 020 674 47 50 020 674 50 00 020 674 47 50
New Zealand International Access Code: 00 Country Code: 64	E-mail (New Zealand): nz_tech_support@dell.com E-mail (Australia): au_tech_support@dell.com Technical Support (for desktop and portable computers) Technical Support (for servers and storage) Home and Small Business Government and Business Sales Fax	0800 443 563 0800 505 098 0800 446 255 0800 444 617 0800 441 567 0800 441 566
Nicaragua	General Support	001-800-220-1006

Country (City) International Access Code Country Code City Code	Department Name or Service Area, Website and E-Mail Address	Area Codes, Local Numbers, and Toll-Free Numbers
Norway (Lysaker)	Website: support.euro.dell.com	
International Access Code: 00	E-mail Support (portable computers):	
Country Code: 47	nor_nbk_support@dell.com	
	E-mail Support (desktop computers):	
	nor_support@dell.com	
	E-mail Support (servers):	
	nordic_server_support@dell.com	
	Technical Support	671 16882
	Relational Customer Care	671 17514
	Home/Small Business Customer Care	23162298
	Switchboard	671 16800
	Fax Switchboard	671 16865
Panama	General Support	001-800-507-0962
Peru	General Support	0800-50-669
Poland (Warsaw)	Website: support.euro.dell.com	
International Access Code: 011	E-mail: pl_support_tech@dell.com	
Country Code: 48	Customer Service Phone	57 95 700
City Code: 22	Customer Care	57 95 999
	Sales	57 95 999
	Customer Service Fax	57 95 806
	Reception Desk Fax	57 95 998
	Switchboard	57 95 999
Portugal	Website: support.euro.dell.com	
International Access Code: 00	E-mail: support.euro.dell.com/pt/en/emaildell/	
Country Code: 351	Technical Support	707200149
	Customer Care	800 300 413
	Sales	800 300 410 or 800 300 411 or 800 300 412 or 21 422 07 10
	Fax	21 424 01 12
Puerto Rico	General Support	1-800-805-7545
St. Kitts and Nevis	General Support	toll-free: 1-877-441-4731

Country (City) International Access Code Country Code City Code	Department Name or Service Area, Website and E-Mail Address	Area Codes, Local Numbers, and Toll-Free Numbers
St. Lucia	General Support	1-800-882-1521
St. Vincent and the Grenadines	General Support	toll-free: 1-877-270-4609
Singapore (Singapore)	Technical Support (Dimension and Inspiron)	toll-free: 1800 394 7430
International Access Code: 005 Country Code: 65	Technical Support (Optiplex, Latitude, and Precision)	toll-free: 1800 394 7488
	Technical Support (PowerEdge and PowerVault)	toll-free: 1800 394 7478
	Customer Service (Penang, Malaysia)	604 633 4949
	Transaction Sales	toll-free: 800 6011 054
	Corporate Sales	toll-free: 800 6011 053
South Africa (Johannesburg)	Website: support.euro.dell.com	
International Access Code: 09/091	E-mail: dell_za_support@dell.com	
Country Code: 27	Gold Queue	011 709 7713
City Code: 11	Technical Support	011 709 7710
	Customer Care	011 709 7707
	Sales	011 709 7700
	Fax	011 706 0495
	Switchboard	011 709 7700
Southeast Asian and Pacific Countries	Customer Technical Support, Customer Service, and Sales (Penang, Malaysia)	604 633 4810
Spain (Madrid)	Website: support.euro.dell.com	
International Access Code: 00	E-mail: support.euro.dell.com/es/es/emaildell/	
Country Code: 34	Home and Small Business	
City Code: 91	Technical Support	902 100 130
	Customer Care	902 118 540
	Sales	902 118 541
	Switchboard	902 118 541
	Fax	902 118 539
	Corporate	
	Technical Support	902 100 130
	Customer Care	902 115 236
	Switchboard	91 722 92 00
	Fax	91 722 95 83

Country (City) International Access Code Country Code City Code	Department Name or Service Area, Website and E-Mail Address	Area Codes, Local Numbers, and Toll-Free Numbers
Sweden (Upplands Vasby) International Access Code: 00 Country Code: 46 City Code: 8	Website: support.euro.dell.com E-mail: swe_support@dell.com E-mail Support for Latitude and Inspiron: Swe-nbk_kats@dell.com E-mail Support for OptiPlex: Swe_kats@dell.com E-mail Support for Servers: Nordic_server_support@dell.com	
	Technical Support	08 590 05 199
	Relational Customer Care	08 590 05 642
	Home/Small Business Customer Care	08 587 70 527
	Employee Purchase Program (EPP) Support	20 140 14 44
	Technical Support Fax	08 590 05 594
	Sales	08 590 05 185
Switzerland (Geneva) International Access Code: 00 Country Code: 41 City Code: 22	Website: support.euro.dell.com E-mail: Tech_support_central_Europe@dell.com E-mail for French-speaking HSB and Corporate Customers: support.euro.dell.com/ch/fr/emaildell/	
	Technical Support (Home and Small Business)	0844 811 411
	Technical Support (Corporate)	0844 822 844
	Customer Care (Home and Small Business)	0848 802 202
	Customer Care (Corporate)	0848 821 721
	Fax	022 799 01 90
	Switchboard	022 799 01 01
Taiwan International Access Code: 002 Country Code: 886	Technical Support (portable and desktop computers) Technical Support (servers and storage) Corporate Sales	toll-free: 00801 86 1011 toll-free: 00801 60 1256 toll-free: 00801 651 227
Thailand International Access Code: 001 Country Code: 66	Technical Support (Optiplex, Latitude, and Precision) Technical Support (PowerEdge and PowerVault) Customer Service (Penang, Malaysia) Sales	toll-free: 1800 0060 07 toll-free: 1800 0600 09 604 633 4949 toll-free: 0880 060 09

Country (City) International Access Code Country Code City Code	Department Name or Service Area, Website and E-Mail Address	Area Codes, Local Numbers, and Toll-Free Numbers
Trinidad/Tobago	General Support	1-800-805-8035
Turks and Caicos Islands	General Support	toll-free: 1-866-540-3355
U.K. (Bracknell)	Website: support.euro.dell.com	
International Access Code: 00	Customer Care website: support.euro.dell.com/uk/en/ECare/Form/Home.asp	
Country Code: 44		
City Code: 1344	E-mail: dell_direct_support@dell.com	
	Technical Support (Corporate/Preferred Accounts/PAD [1000+ employees])	0870 908 0500
	Technical Support (direct/PAD and general)	0870 908 0800
	Global Accounts Customer Care	01344 373 186
	Home and Small Business Customer Care	0870 906 0010
	Corporate Customer Care	01344 373 185
	Preferred Accounts (500–5000 employees) Customer Care	0870 906 0010
	Central Government Customer Care	01344 373 193
	Local Government & Education Customer Care	01344 373 199
	Health Customer Care	01344 373 194
	Home and Small Business Sales	0870 907 4000
	Corporate/Public Sector Sales	01344 860 456
	Home and Small Business Fax	0870 907 4006
Uruguay	General Support	toll-free: 000-413-598-2521

Country (City) International Access Code Country Code City Code	Department Name or Service Area, Website and E-Mail Address	Area Codes, Local Numbers, and Toll-Free Numbers
U.S.A. (Austin, Texas)	Automated Order-Status Service	toll-free: 1-800-433-9014
International Access Code: 011 Country Code: 1	AutoTech (portable and desktop computers) Consumer (Home and Home Office) Technical Support Customer Service DellNet™ Service and Support Employee Purchase Program (EPP) Customers Financial Services website: www.dellfinancialservices.com Financial Services (lease/loans) Financial Services (Dell Preferred Accounts [DPA]) Business Customer Service and Technical Support Employee Purchase Program (EPP) Customers Printers and Projectors Technical Support Public (government, education, and healthcare) Customer Service and Technical Support Employee Purchase Program (EPP) Customers Dell Sales Dell Outlet Store (Dell refurbished computers) Software and Peripherals Sales Spare Parts Sales Extended Service and Warranty Sales Fax Dell Services for the Deaf, Hard-of-Hearing, or Speech-Impaired	toll-free: 1-800-247-9362 toll-free: 1-800-624-9896 toll-free: 1-800-624-9897 toll-free: 1-877-Dellnet (1-877-335-5638) toll-free: 1-800-695-8133 toll-free: 1-877-577-3355 toll-free: 1-800-283-2210 toll-free: 1-800-822-8965 toll-free: 1-800-695-8133 toll-free: 1-877-459-7298 toll-free: 1-800-456-3355 toll-free: 1-800-234-1490 toll-free: 1-800-289-3355 or toll-free: 1-800-879-3355 toll-free: 1-888-798-7561 toll-free: 1-800-671-3355 toll-free: 1-800-357-3355 toll-free: 1-800-247-4618 toll-free: 1-800-727-8320 toll-free: 1-877-DELLTTY (1-877-335-5889)
U.S. Virgin Islands	General Support	1-877-673-3355
Venezuela	General Support	8001-3605

Index

A

audio. *See* sound

B

battery

problems, 25
replacing, 79

BIOS, 77

booting to a USB device, 21

C

cards

adding, 65
connectors, 61

CD drive

light, 54
problems, 26

CD-RW drive

problems, 26

CDs

copying, 19

Check Disk, 27

computer

closing cover, 72
crashes, 30-31
internal parts, 60
restore to previous state, 49-50
specifications, 73
stops responding, 30

conflicts

drivers, 48
resolving software and
hardware
incompatibilities, 52

connectors

network adapter, 56

copying CDs and DVDs

general information, 19
helpful tips, 20
how to, 19

cover

closing, 72

D

Dell

contacting, 83

Dell Diagnostics, 46

Dell Support website, 10, 32

Device Driver Rollback, 49

diagnostics, Dell, 46

display. *See* monitor

documentation, 9

finding, 9

help file, 9

online, 10

setup diagram, 9

drivers

definition, 48
reinstalling, 49
troubleshooting, 48

drives

problems, 26

DVD drive

light, 54
problems, 27

DVDs

copying, 19

E

e-mail

problems, 27

error messages, 29

Express Service Code, 9

F

fixing problems

Dell Diagnostics, 46

front door

reattaching, 57

H

hard drive

light, 54
problems, 27

hardware
 drivers, 48
 problems, 32
Hardware Troubleshooter, 52
Help and Support Center, 10
help files
 accessing, 9-10, 25
Hyper-Threading, 20

I

IEEE 1394, 16
 problems, 33
Internet
 problems, 27
Internet connection
 about, 18
 options, 18
 setting up, 18
IRQ conflicts, 52

K

keyboard
 problems, 33

L

lights
 CD/DVD drive, 54
 hard drive, 54

M

memory
 connectors, 61
messages
 error, 29
Microsoft License Label, 9
modem
 problems, 27
monitor
 blank, 40
 hard to read, 41
 problems, 40
motherboard. *See* system board

N

network
 problems, 35
network adapter
 connector, 56
NIC. *See* network adapter

O

operating system
 reinstalling Windows XP, 50

P

password
 clearing system setup, 78

PC Cards

 installing, 63
 problems, 35
 removing, 64
 types, 62

power

 problems, 36
 turning off your computer, 21

power light

 conditions, 36

printer

 cable, 14
 connecting, 13
 parallel, 14
 problems, 37
 setting up, 13
 USB, 15

problems

 battery, 25
 blue screen, 31
 CD drive, 26
 CD-RW drive, 26
 computer crashes, 30-31
 computer stops responding, 30
 drives, 26
 DVD drive, 27
 e-mail, 27
 error messages, 29
 finding solutions, 23
 general, 30
 hard drive, 27
 hardware, 32
 IEEE 1394, 33
 Internet, 27
 keyboard, 33
 modem, 27
 monitor hard to read, 41

problems (*continued*)
monitor is blank, 40
network, 35
other, 32
PC cards, 35
power, 36
power light conditions, 36
printer, 37
program crashes, 30
program stops responding, 30
programs and Windows
compatibility, 30
restore to previous state, 49-50
scanner, 38
screen hard to read, 41
screen is blank, 40
software, 30-31
sound and speakers, 39
troubleshooting chart, 23
video and monitor, 40
volume adjusting, 39

Program Compatibility
Wizard, 30

R

reinstalling
drivers, 49
Windows XP, 50

S

safety instructions, 7
scanner
problems, 38
screen. *See* monitor

settings
system setup program, 77
setup diagram, 9
shutting down your
computer, 21
software
Hyper-Threading, 20
problems, 30-31
reinstalling software, 49
sound
problems, 39
volume, 39
speaker
problems, 39
volume, 39
specifications, 73
support
contacting Dell, 83
system board, 61
System Restore, 49-50
system setup program, 77

T

Tell Me How help file
accessing, 9, 25
Troubleshooting
Help and Support Center, 25
troubleshooting
conflicts, 52
Dell Diagnostics, 46
Device Driver Rollback, 49
drivers, 48
Hardware Troubleshooter, 52

troubleshooting (*continued*)
Help and Support Center, 10
restore to previous state, 49-50
troubleshooting. *See*
problems
turning off your computer, 21

U

USB devices, booting to, 21

V

video
problems, 40
video memory
connector, 61
volume
adjusting, 39

W

Windows XP
Device Driver Rollback, 49
Hardware Troubleshooter, 52
Help and Support Center, 10
help, accessing, 25
Hyper-Threading, 20
Program Compatibility
Wizard, 30
reinstalling, 50
scanner, 38
System Restore, 49-50
wizards
Program Compatibility
Wizard, 30

